

*PROMO ARTICOLI CONSUMO "2016-base"	
*check-correzioni al 30-12-2016	Validità promozione al 31-GENNAIO-2017
*	
QUOTAZIONI PARTICOLARI RISERVATE AGLI UTILIZZATORI FINALI su ARTICOLI CONSUMO per LABORATORIO	
Punto 1°)	*CON ORDINI di EURO 400,00= imponibile OLTRE IVA IN CASO DI ORDINI DI IMPONIBILE (LORDO) "NON INFERIORE ad EURO 400,00 (Quattrocento/00)PER ARTICOLI DEL PRESENTE CATALOGO OFFERTA-PROMO POTRETE RICEVERE UNO SCONTO REALE PARI al 10% DELL' ORDINATO
Punto 2°)	*CON ORDINI di EURO 600,00= imponibile OLTRE IVA IN CASO DI ORDINI DI IMPONIBILE (LORDO) "NON INFERIORE ad EURO 600,00 (SEIcento/00)PER ARTICOLI DEL PRESENTE CATALOGO OFFERTA-PROMO POTRETE RICEVERE UNO SCONTO REALE PARI al 15% DELL' ORDINATO
Punto 3°)	*CON ORDINI di EURO 1.000,00= imponibile OLTRE IVA IN CASO DI ORDINI DI IMPONIBILE (LORDO) "NON INFERIORE ad EURO 1.000,00 (MILLE/00)PER ARTICOLI DEL PRESENTE CATALOGO OFFERTA-PROMO POTRETE RICEVERE UNO SCONTO REALE PARI al 20% DELL' ORDINATO
.....	ULTERIORI CONDIZIONI GENERALI DI VENDITA SONO : LA RESA FRANCO SEDE DEL CLIENTE E' ASSICURATA PER ORDINATIVI DI IMPONIBILE "NON INFERIORE ad Euro 400,00 (QUATTROCENTO)" oltre IVA <i>(POSSIBILITA' DI CUMULARE ANCHE CON ALTRI ARTICOLI DEL NS. PROGRAMMA</i> <i>DI VENDITA, QUALI PRODOTTI CHIMICI -STRUMENTI E LORO ACCESSORI).</i> PER OGNI ORDINE DI IMPONIBILE INFERIORE A QUANTO SOPRA SPECIFICATO VIENE RICHiesto UN CONTRIBUTO SPESE SPEDIZIONE PARI AD EURO 20,00 (venti//00) oltre IVA.
Interpellateci inviando Richieste direttamente al seguente indirizzo mail : edl@delchimica.com	

SI RESTA A DISPOSIZIONE PER OGNI ULTERIORE CHIARIMENTO ,SE NECESSARIO.

CON I PIU' DISTINTI SALUTI

Eugenio de Luca

mail : edl@delchimica.com

(Offerta- 09/2016) Pag. 01 di 36

*check-correzioni al 30-12-2016

SEGUE . / .







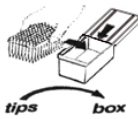

***PROMO ARTICOLI CONSUMO "2016-base"**

Validità promozione al 31-GENNAIO-2017

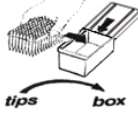
Gamma 19-		segue ./.	Gamma 20- alfabetica	
Puntali senza Filtro fino 10 uL	pag. 03			
Puntali senza Filtro fino 200 uL	pag. 03-04		Piastre-Plates PCR	pag. 22-23
Puntali senza Filtro fino 1250 uL	pag. 04-05		Piastre Microtiter PS 96-Flat	pag. 24
Puntali con Filtro = Famiglia 19-60...	pag. 06-07		Piastre Microtiter PS 96-U	pag. 24
Puntali con Filtro = Famiglia 19-79...	pag. 07		Piastre Microtiter PS 96-V	pag. 24
Puntali senza Filtro GILSON	pag. 08		Pipette Pasteur in Vetro	pag. 24
Puntali senza Filtro RAININ cilindrici	pag. 08		Pipette Pasteur in PET monouso	pag. 24
			Pipette Sierologiche e TC monouso	pag. 25
Gamma 22-			Pipettatore Elettronico E-FILL	pag. 26
Guanti No-Latex e LATEX	pag. 09		Pipettatore Elettronico TurboFix TPP	pag. 26
Guanti Eko-Nitrile e NITRILE-DOC	pag. 10		Pipettatore Elettronico XP WG	pag. 26
			PARAFILM M = Rolls	pag. 27
Gamma 20- alfabetica			PARAFILM M = Accessori	pag. 27
Anse a T	pag. 11		Provette cilindriche PS e PP per TC	pag. 27
Anse a L	pag. 11		Provette coniche PP da 15 e 50 ml.	pag. 27
Anse 1 uL o 10 uL	pag. 11		Portaprovette Racks 4 Lati ...4010..	pag. 28
Anse a Punta	pag. 11		Portaprovette Racks 4 Lati ...5010..	pag. 28
Asciugatutto (Carte in Rotoloni)	pag. 17		Portaprovette Racks 4 Lati ...8010...	pag. 28
			Portaprovette PCR Rack tipo B	pag. 28
Buste Sterilizzazione	pag. 11		Portaprovette PCR Rack tipi A + B	pag. 28
Bicchieri PP Tricorno	pag. 12		Portaprovette PCR tipi 220-222-224	pag. 28
Bicchieri cilindrici PP e TPX	pag. 12-13		Portaprovette K a 100 p. x diam. 11	pag. 29
Bottiglioni HDPE con Rubinetto	pag. 13		Portaprovette K a 90 p. x diam. 13	pag. 29
			Portaprovette K a 60 p. x diam. 16	pag. 29
Cilindri PP e TPX	pag. 13		Portaprovette K a 40 p. x diam. 19	pag. 29
Cotone idrofilo (ovatta marca oro)	pag. 14		Portaprovette K a 24 p. x diam. 30	pag. 29
Cotone batteriologia (idrofobo)	pag. 14		Portaprovette wire/met. 15 e 50 ml.	pag. 29
Cuvette monouso PS-PMMA-UV	pag. 15		Portaprovette PP 80 posti 1,5 ml.	pag. 29
Cryovials sterili	pag. 16		Portaprov. PP 64 posti 1,5-2,0 e 0,5	pag. 29
Carta bibula e da banco	pag. 16		Portaprov. PP 96 posti 1,5-2,0 e 0,5	pag. 29
Carta crespata	pag. 16		Portaprovette-Racks CHILLER	pag. 30
Carte (Rotoloni) Asciugatutto	pag. 17			
			Roll Alluminio	pag. 30
Detergenti/concentrati x Vetrerie etc.	pag. 17		Roll Pellicola	pag. 30
Etichette x MicroTubi e Provette	pag. 22		Scatole Cryoboxes cartone PVC coated	pag. 30-31
			Grids/alveari cartone per dette	pag. 30-31
Filtri sterili x Siringhe	pag. 17		Scatole Cryoboxes PP 50 x 0,5 ml.	pag. 31
			Scatole Cryoboxes PP 50 x 1,5-2,0 ml.	pag. 31
Grasso al silicone	pag. 18		Scatole Cryoboxes PP 81 x 1,5-2,0 ml.	pag. 31
			Scatole Cryoboxes PP 100x 1,5-2,0 ml.	pag. 31
Indicatori (Roll) sterilizzazione	pag. 18		Scatole Portavetrini PP-ABS	pag. 32
			Siringhe INJECT a 2 componenti LuerSlip	pag. 32
Microtubi conici 0,2 singoli x PCR	pag. 18		Siringhe Discardit a 2 componenti LuerSlip	pag. 33
Microtubi conici 0,2 in Strips x PCR	pag. 19		Siringhe HSW a 2 componenti LuerLock	pag. 33
Microtubi conici 0,1 speciali x PCR	pag. 19			
Microtubi conici 0,5 singoli x PCR	pag. 20		Vetrini portaoggetto rettangolari	pag. 34
Microtubi conici 0,5 ml. Graduati	pag. 20		Vetrini copri oggetto quadri e rett.	pag. 34
Microtubi conici 1,5 ml. Graduati	pag. 20		Vetrini copri oggetto circolari	pag. 34
Microtubi conici 2,0 ml. Graduati	pag. 20		Vaschette Pesata HIPS QUADRE	pag. 35
Microtubi conici 5,0 ml. Graduati	pag. 20		Vaschette Pesata HIPS DIAMOND	pag. 35
Microtubi conici collo vite + tappi vite	pag. 21		Vaschette Pesata in Alluminio	pag. 35
MicroTubi = PCR Plates	pag. 22-23		Vials vetro 1st class con tappi vite	pag. 36

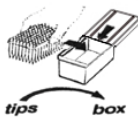

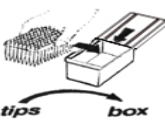





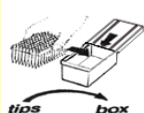

*PROMO ARTICOLI CONSUMO "2016-base"

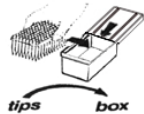
Validità promozione al 31-GENNAIO-2017

codice gamma 19-.....	confezione	tipo Confez.	Articolo	Prezzo Unit. x Conf in Euro iva esclusa	Note
					sul Catalogo vedi pag. A03
19-0930002	1 x1.000 pz	Sfusi-busta	UnidispTips HG-5 (10) nano	26,50	
19-0930002.x10	10 x1.000 pz	Sfusi-buste	*Range 0,1 – 10 µl.	212,00	
19-0930002.x20	20 x1.000 pz	Sfusi-buste	<i>(richiedono Rack tipo 4110...Basso)</i>	397,50	
19-0930053.x50	50 x 96 tips	Refill- Autocl.	idem	178,00	
19-0930512	10 x 96 tips	Racksl Autocl	idem	47,50	
19-0930512.x50	50 x 96 tips	Racksl Autocl	idem	190,00	
					sul Catalogo vedi pag. A04
19-1030100	1 x1.000 pz	Sfusi-busta	UnidispTips HG10 short	8,40	
19-1030100.x10	10 x1.000 pz	Sfusi-buste	*Range 0,1 – 10 µl.	67,20	
19-1030100.x20	20 x1.000 pz	Sfusi-buste	<i>(richiedono Rack tipo 4110...Basso)</i>	126,00	
19-1030113.x50	50 x 96 tips	Refill- Autocl.	idem	127,00	
19-1030512	10 x 96 tips	Racksl Autocl	idem	35,00	
19-1030512.x50	50 x 96 tips	Racksl Autocl	idem	157,50	
					sul Catalogo vedi pag. A05
19-1032100	1 x1.000 pz	Sfusi-busta	UnidispTips HG10/X-Long	9,00	
19-1032100.x10	10 x1.000 pz	Sfusi-buste	*Range 0,1 – 10 µl.	72,00	
19-1032100.x20	20 x1.000 pz	Sfusi-buste	<i>(richiedono Rack tipo 4110...Basso)</i>	135,00	
19-1032113.x50	50 x 96 tips	Refill- Autocl.	idem	133,00	
19-1032512	10 x 96 tips	Racksl Autocl	idem	36,00	
19-1032512.x50	50 x 96 tips	Racksl Autocl	idem	162,00	
					fuori Catalogo
19-2030213..x50	50 x 96 tips	Refill- Autocl.	UnidispTips HYC-210 yellow	104,00	Esaurimento
19-2030215.ZS	10 x 96 tips	Refill- Sterili	*Range 1 – 200 µl. cut-point	27,60	Esaurimento







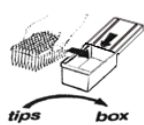

*PROMO ARTICOLI CONSUMO "2016-base"

Validità promozione al 31-GENNAIO-2017

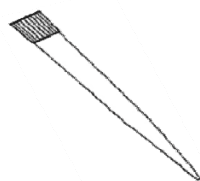
codice gamma 19-.....	confezione	tipo Confez.	Articolo	Prezzo Unit. x Conf in Euro iva esclusa	Note
					sul Catalogo vedi pag. A08
19-2032200	1 x1.000 pz	Sfusi-busta	UnidispTips HGY-220 yellow	4,50	
19-2032200.x10	10 x1.000 pz	Sfusi-buste	*Range 1 – 200 µl. beveled	36,00	
19-2032200.x25	25 x1.000 pz	Sfusi-buste	<i>(richiedono Rack tipo 4115...ALTO)</i>	84,50	
19-2032213.x50	50 x 96 tips	Refill- Autocl.	idem	114,00	
19-2032512	10 x 96 tips	Racksl Autocl	idem	32,00	
19-2032512.x50	50 x 96 tips	Racksl Autocl	idem	144,00	
					sul Catalogo vedi pag. A09
19-2033200	1 x1.000 pz	Sfusi-busta	UnidispTips HB-200 neutri	7,00	
19-2033200.x10	10 x1.000 pz	Sfusi-buste	*Range 1 – 200 µl. bev/grad.	56,00	
19-2033200.x25	25 x1.000 pz	Sfusi-buste	<i>(richiedono Rack tipo 4115...ALTO)</i>	131,25	
19-2033213.x50	50 x 96 tips	Refill- Autocl.	idem	120,00	
19-2033512	10 x 96 tips	Racksl Autocl	idem	35,00	
19-2033512.x50	50 x 96 tips	Racksl Autocl	idem	157,50	
					sul Catalogo vedi pag. A18
19-3591000	1 x1.000 pz	Sfusi-busta	UnidispTips HG-1000 neutri	7,80	
19-3591000.x10	10 x1.000 pz	Sfusi-buste	*Range 50 – 1000 µl. cut-point	62,40	
19-3591000.x30	30 x1.000 pz	Sfusi-buste	<i>(richiedono Rack tipo 7111...Alto)</i>	175,50	
19-3591013.x50	50 x 96 tips	Refill- Autocl.	idem	127,00	
19-3591513	10 x 96 tips	Racksl Autocl	idem	35,00	
19-3591513.x50	50 x 96 tips	Racksl Autocl	idem	157,50	
					sul Catalogo vedi pag. A19
19-3695000	1 x1.000 pz	Sfusi-busta	UnidispTips HE-1000 neutri	6,80	
19-3695000.x10	10 x1.000 pz	Sfusi-buste	*Range 100–1000 µl. cut-point	54,40	
19-3695000.x30	30 x1.000 pz	Sfusi-buste	<i>(richiedono Rack tipo 7109...Alto)</i>	153,00	
19-3695013.x50	50 x 96 tips	Refill- Autocl.	idem	116,00	
19-3695513	10 x 96 tips	Racksl Autocl	idem	33,00	
19-3695513.x50	50 x 96 tips	Racksl Autocl	idem	148,50	

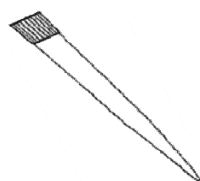
*PROMO ARTICOLI CONSUMO "2016-base"

Validità promozione al 31-GENNAIO-2017

codice gamma 19-.....	confezione	tipo Confez.	Articolo	Prezzo Unit. x Conf in € iva esclusa	Note
					sul Catalogo vedi pag. A20
19-3801203	1 x1.000 pz	Sfusi-busta	UnidispTips HNE-1250 neutri	8,00	
19-3801203.x10	10 x1.000 pz	Sfusi-buste	*Range 50 –1250 µl. cut-point	64,00	
19-3801203.x30	30 x1.000 pz	Sfusi-buste	<i>(richiedono Rack tipo 7109...Alto)</i>	180,00	
19-3801213.x50	50 x 96 tips	Refill- Autocl.	idem	128,00	
19-3801513	10 x 96 tips	Racksl Autocl	idem	35,50	
19-3801513.x50	50 x 96 tips	Racksl Autocl	idem	159,75	
					sul Catalogo vedi pag. A22
19-4055000.x500	2 x 250 pz	Sfusi-busta	UnidispTips L-5000 azzurri	28,00	
19-4055000.x990	4 x 250 pz	Sfusi-buste	*Range 500–5.000 µl. cut-point	44,80	
19-4055512.x200	4 x 50 tips	Racksl Autocl	Idem già montati in Racks	36,00	
					sul Catalogo vedi pag. A23
19-4058000.x500	2 x 250 pz	Sfusi-busta	UnidispTips BH/SX-5000 clear	28,00	
19-4058000.x990	4 x 250 pz	Sfusi-buste	*Range 500–5.000 µl. cut-point	44,80	
19-4058512.x200	4 x 50 tips	Racksl Autocl	Idem già montati in Racks	36,00	
					sul Catalogo vedi pag. A24
19-4060000.x500	2 x 250 pz	Sfusi-busta	UnidispTips FP/BR-5000 clear	36,00	
19-4060000.x990	4 x 250 pz	Sfusi-buste	*Range 500–5.000 µl. cut-point	57,60	
19-4060512.x200	4 x 50 tips	Racksl Autocl	Idem già montati in Racks	38,00	

***PROMO ARTICOLI CONSUMO "2016-base"**

Validità promozione al 31-GENNAIO-2017

codice	confezione	tipo Confez.	Articolo	Prezzo Unit. x Conf in Euro iva esclusa	Note
gamma 19-.....					
colletto conico					

UNIDISP RESEARCH UNI-GRADE UNIFILTER TIPS
***** (dichiarati RNase Free and DNase Free) *****



UFG - 5/E

Rid Aut.

Rid Ster.



Rid Aut.

Rid Ster.

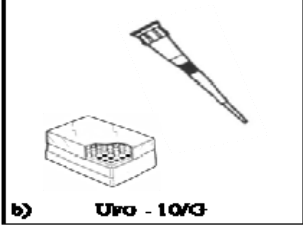

UFG - 10/G

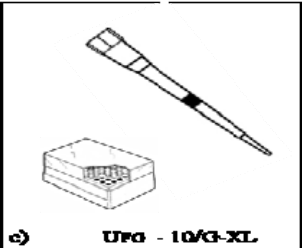

UFG - 10/G-XL

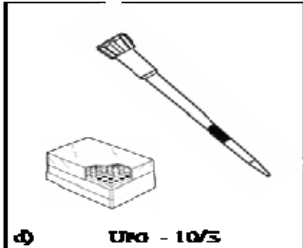

UFG - 10/S

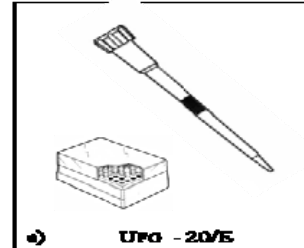

UFG - 20/E

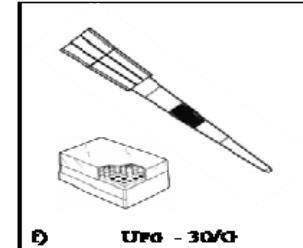

UFG - 30/G

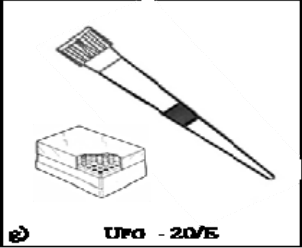

UFG - 20/E

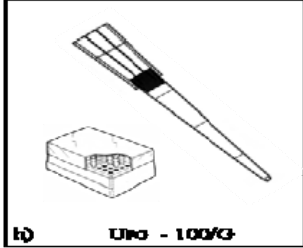

UFG - 100/G

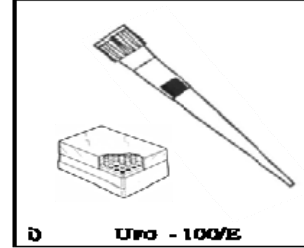

UFG - 100/E

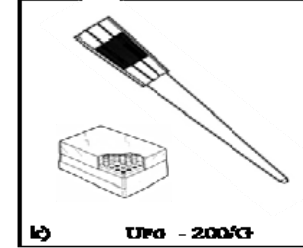

UFG - 200/G



UFG - 200/Long

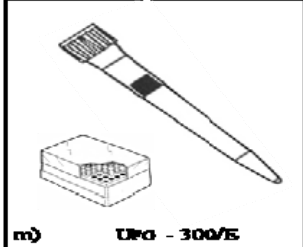

UFG - 300/E

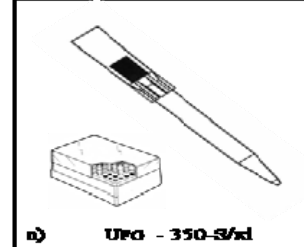

UFG - 350-S/d

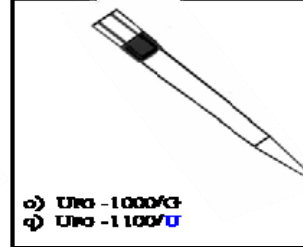

UFG - 1000/G
UFG - 1100/U

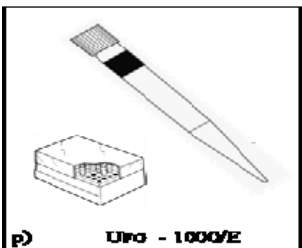

UFG - 1000/E

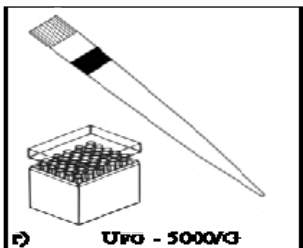

UFG - 5000/G

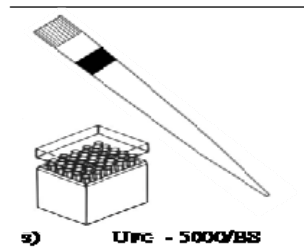

UFG - 5000/BS

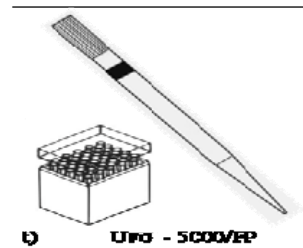

UFG - 5000/EP

TUTTI LOW-RETENTION - RNASE, DNASE & PYROGENS FREE // RICHIEDETE LE SCHEDE TECNICHE RIPORTANTI "INFO su CALZABILITA' SPECIFICA"

***PROMO ARTICOLI CONSUMO "2016-base"**

Validità promozione al 31-GENNAIO-2017

codice gamma 19-.....	confezione	tipo Confez.	Articolo	Prezzo Unit. x Conf in Euro iva esclusa	Note
UNIDISP RESEARCH FILTERTIPS UFG-Grade = Famiglia codifica iniziante con 19-60..... sono puntali con filtro buona qualità routinaria ,low retention, dichiarati Rnase, Dnase, Pyrogens & PCR inhibitors free					
19-6010007 (a)	1 x 960 tips	Racks/ Sterili	Filtertips UFG- 5/E -xl fino 5 µl.	59,40	nano type
19-6010017 (b)	1 x 960 tips	Racks/ Sterili	Filtertips UFG-10/G 0,1 - 10 µl.	49,60	short type
19-6012017 (c)	1 x 960 tips	Racks/ Sterili	Filtertips UFG-10/G-xl 0,1 - 10 µl.	49,60	Long type
19-6015017 (d)	1 x 960 tips	Racks/ Sterili	Filtertips UFG-10/E -xl fino 10 µl.	49,60	Long Cristall
19-6015027 (d)	1 x 960 tips	Racks/ Sterili	Filtertips UFG-20/E -xl fino 20 µl.	59,40	Long Cristall
19-6020037 (f)	1 x 960 tips	Racks/ Sterili	Filtertips UFG-30/G fino 30 µl.	49,60	universal type
19-6025037 (g)	1 x 960 tips	Racks/ Sterili	Filtertips UFG-20/E fino 20 µl.	49,60	esaurimento
19-6020107 (h)	1 x 960 tips	Racks/ Sterili	Filtertips UFG-100/G fino 100 µl.	49,60	universal type
19-6025107 (h)	1 x 960 tips	Racks/ Sterili	Filtertips UFG-100/G fino 100 µl.	49,60	esaurimento
19-6020207 (k)	1 x 960 tips	Racks/ Sterili	Filtertips UFG-200/G fino 200 µl.	49,60	universal type
19-6420277	1 x 960 tips	Racks/ Sterili	Filtertips ULB- 20 – 100 - 200 µl	57,00	*Tripla range
19-6030307 (m)	1 x 960 tips	Racks/ Sterili	Filtertips UFG-300/E fino 300 µl.	49,60	universal type
19-6038357 (n)	1 x 960 tips	Racks/ Sterili	Filtertips UFG-350/S-xL fino 300 µl.	59,40	universal type
19-6040907 (o)	1 x 960 tips	Racks/ Sterili	Filtertips UFG-1000/G fino 1000 µl	50,40	universal type
19-6045907 (p)	1 x 960 tips	Racks/ Sterili	Filtertips UFG-1000/E fino 1000 µl	50,40	universal type
19-6048909 (q)	1 x 960 tips	Racks/ Sterili	Filtertips UFG-1100/U fino 1100+µl	50,40	universal type
19-6055007 (r)	1 x 200 tips	Racks/ Sterili	Filtertips UFG-5000/G fino 5000 µl	62,00	univ. Gilson,etc
19-6058007 (s)	1 x 200 tips	Racks/ Sterili	Filter UFG-5000/BhSxEp fino 5000µl	62,00	univ. Bihit,Sx,Ep
19-6060007 (t)	1 x 200 tips	Racks/ Sterili	Filtertips UFG-5000/F fino 5000 µl	62,00	univ. Brand,etc
19-6090007 (t)	1 x 100 tips	Racks/ Sterili	Filtertips UFG10.000/G fino 10 ml	62,00	univ. Gilson,etc
19-6098907 (t)	1 x 100 tips	Racks/ Sterili	Filtertips UFG10.000/BhEp fino 10ml	62,00	univ. Biohit,Ep
UNIDISP RESEARCH FILTERTIPS FTG-Grade = Famiglia codifica iniziante con 19-79..... sono una qualità superiore di puntali con filtro ,low retention, oltre che dichiarati, sono anche Certificati Rnase, Dnase, Pyrogens, PCR inhibitors & ATP free					
(2x)FTG-10/G	(2x)FTG-11/U-xL	(2x)FTG-20/G	(1x)FTG-100/G	(2x)FTG-200/G	(1x)FTG-1250
19-7910009 (=)	1 x 960 tips	Racks/ Sterili	Filtertips FTG- Mixed Range Confezione Speciale contenente tutti i Tipi	59,00	short type
19-7910019 (b)	1 x 960 tips	Racks/ Sterili	Filtertips FTG-10/G 0,1 - 10 µl.	51,30	short type
19-7911019 (c)	1 x 960 tips	Racks/ Sterili	Filtertips FTG-11/U-xl 0,1 – 10+ µl.	51,30	Long type
19-7920039 (f)	1 x 960 tips	Racks/ Sterili	Filtertips FTG-20/G fino 20 µl.	51,30	universal type
19-7920109 (h)	1 x 960 tips	Racks/ Sterili	Filtertips FTG-100/G fino 100 µl.	51,30	universal type
19-7920209 (k)	1 x 960 tips	Racks/ Sterili	Filtertips FTG-200/G fino 200 µl.	51,30	universal type
19-7940909 (o)	1 x 960 tips	Racks/ Sterili	Filtertips FTG-1000/U fino 1000 µl.	53,00	universal type
19-7940959 (-)	1 x 960 tips	Racks/ Sterili	Filtertips FTG-1250/UxL fino 1250+µl	58,50	universal type

*PROMO ARTICOLI CONSUMO "2016-base"







Validità promozione al 31-GENNAIO-2017

codice gamma 19-.....	confezione	tipo Confez.	Articolo	Prezzo Unit. x Conf in Euro iva esclusa	Note
GILSON Originali colletto conico				GILSON Originali colletto conico	
19-90F161630.x01	1 x1.000 pz	Sfusi-busta	GILSON tips D-10.V originali	30,00	==no=
19-90F161630.x10	10 x1.000 pz	Sfusi-buste	idem come sopra Bulk/ 0,1- 10 µl	269,00	300,00
19-90F171100.x01	1 x 960 pz	Racks/Autocl	GILSON tips D-10.T orig. già montati in GilsonRacks	53,00	54,00
19-90F171100.xUD	1 x 960 pz	Racks/Autocl	GILSON orig. D-10.V+UDTray ma montati in UDRacks	42,00	extra/UD
19-90F161450.x01	1 x1.000 pz	Sfusi-busta	GILSON tips DL-10.V originali	30,00	==no=
19-90F161450.x10	10 x1.000 pz	Sfusi-buste	idem come sopra Bulk/ 0,1- 20 µl	269,00	300,00
19-90F171200.x01	1 x 960 pz	Racks/Autocl	GILSON tips DL-10.T orig. già montati in GilsonRacks	53,00	54,00
19-90F171200.xUD	1 x 960 pz	Racks/Autocl	GILSON orig. DL-10.V+UDTray ma montati in UDRacks	42,00	extra/UD
19-90F161930.x01	1 x1.000 pz	Sfusi-busta	GILSON tips D-200.V originali	19,50	==no=
19-90F161930.x10	10 x1.000 pz	Sfusi-buste	idem come sopra Bulk/ fino 200 µl	175,00	196,00
19-90F171300.x01	1 x 960 pz	Racks/Autocl	GILSON tips D-200.V+T orig. già montati in UDRacks	40,00	45,00
19-90F171300.xUD	1 x 960 pz	Racks/Autocl	GILSON orig. D-200.V+UDTray ma montati in UDRacks	32,00	extra/UD
19-90F161670.x01	1 x1.000 pz	Sfusi-busta	GILSON tips D-1000.V orig.	19,50	==no=
19-90F161670.x10	10 x1.000 pz	Sfusi-buste	idem come sopra Bulk/ fino 1.000 µl	175,00	196,00
19-90F171500.x01	1 x 960 pz	Racks/Autocl	GILSON tips D-1000.T orig. già montati in UDRacks	41,00	47,00
19-90F171500.xUD	1 x 960 pz	Racks/Autocl	GILSON orig. D-1000.V+UDTray ma montati in UDRacks	34,00	extra/UD
RAININ compatibili colletto cilindrico				RAININ compatibili colletto cilindrico	
19-97U01000504.x01	1 x1.000 pz	Sfusi-busta	UD- RAININ UDR-L.10 *Range 0,1 – 20 µl.	27,50	
19-97U01002930.x01	1 x 960 pz	Racks/Autocl	UD- RAININ UDR-L.10 già montati in UDRacks	50,00	
19-97U02500504.x01	1 x1.000 pz	Sfusi-busta	UD- RAININ UDR-L.250 *Range 0,5 – 250 µl.	26,00	
19-97U02502932.x01	1 x 960 pz	Racks/Autocl	UD- RAININ UDR-L.250 già montati in UDRacks	50,00	
19-97U09000506.x01	1 x1.000 pz	Sfusi-busta	UD- RAININ UDR-L.1000 *Range 50 – 1000 µl.	30,00	
19-97U09002922.x01	1 x 768 pz	Racks/Autocl	UD- RAININ UDR-L.1000 già montati in UDRacks	50,00	
colletto cilindrico					
19-97U01002928.x01	1 x 960 pz	Racks/Sterili	UD- RAININ Filtertips RF-L.10 *Range 0,1 – 20 µl.	99,00	
19-97U02502932.x01	1 x 960 pz	Racks/Sterili	UD- RAININ Filtertips RF-L.200 *Range 0,5 – 200 µl.	99,00	
19-97U09002920.x01	1 x 768 pz	Racks/Sterili	UD- RAININ Filtertips RF-L.1000 *Range 50 – 1000 µl.	88,00	





***PROMO ARTICOLI CONSUMO "2016-base"**

-correzioni al 17-11-2016

Validità promozione al 31-GENNAIO-2017



codice	confezione	tipo Confez.	Articolo	Prezzo Unit. x Conf in € iva esclusa	Note
gamma 22-.....					
<p>DOC-INNERCLORIN peso di ogni guanto 5,7 grammi</p> <div style="display: flex; justify-content: space-around;">   </div> <p>LATEX (white/I più venduti) PowderFree , spessore 20 + micron</p> <div style="text-align: right;">  </div>					
22-01709.xx1 spessore 20+ micron	1 x100 pz	box	Latex Gloves clorin Extra-SMALL PowderFree , colore white	6,50	
22-01709.x10	10 x100 pz	cartone orig.	idem come sopra / bulkcase	57,60	1.000 pezzi
22-01711.xx1 spessore 20+ micron	1 x100 pz	box	Latex Gloves clorin S M A L L PowderFree , colore white	6,50	
22-01711.x10	10 x100 pz	cartone orig.	idem come sopra / bulkcase	57,60	1.000 pezzi
22-01713.xx1 spessore 20+ micron	1 x100 pz	box	Latex Gloves clorin MEDIUM PowderFree , colore white	6,50	
22-01713.x10	10 x100 pz	cartone orig.	idem come sopra / bulkcase	57,60	1.000 pezzi
22-01715.xx1 spessore 20+ micron	1 x100 pz	box	Latex Gloves clorin L A R G E PowderFree , colore white	6,50	
22-01715.x10	10 x100 pz	cartone orig.	idem come sopra / bulkcase	57,60	1.000 pezzi
22-01717.xx1 spessore 20+ micron	1 x100 pz	box	Latex Gloves clorin Extra-LARGE PowderFree , colore white	6,50	
22-01717.x10	10 x100 pz	cartone orig.	idem come sopra / bulkcase	57,60	1.000 pezzi
<p>DOC-INNERCOATED peso di ogni guanto 5,7 grammi</p> <div style="display: flex; justify-content: space-around;">   </div> <p>LATEX Innercoated IC (box giallino) PowderFree , spessore 20+ micron</p> <p>(IMPORTANTE.....CALZABILI ANCHE IN DOPIO.....UNO SOPRA L'ALTRO)</p> <div style="text-align: right;">  <p>SOSPESI</p>  </div>					
22-02209 spessore 20+ micron	1 x100 pz	box	Latex Gloves innerc. Extra-SMALL PowderFree , colore white	6,50	
22-02209.x10	10 x100 pz	cartone orig.	idem come sopra / bulkcase	57,60	1.000 pezzi
22-02211 spessore 20+ micron	1 x100 pz	box	Latex Gloves innercoated SMALL PowderFree , colore white	6,50	
22-02211.x10	10 x100 pz	cartone orig.	idem come sopra / bulkcase	57,60	1.000 pezzi
22-02213 spessore 20+ micron	1 x100 pz	box	Latex Gloves innercoated MEDIUM PowderFree , colore white	6,50	
22-2213.x10	10 x100 pz	cartone orig.	idem come sopra / bulkcase	57,60	1.000 pezzi
22-02215 spessore 20+ micron	1 x100 pz	box	Latex Gloves innercoated LARGE PowderFree , colore white	6,50	
22-02215.x10	10 x100 pz	cartone orig.	idem come sopra / bulkcase	57,60	1.000 pezzi

***PROMO ARTICOLI CONSUMO "2016-base"**Validità promozione al **31-GENNAIO-2017**

codice gamma 22-.....	confezione	tipo Confez.	Articolo	Prezzo Unit. x Conf in Euro iva esclusa	Note
<p>DOC-PW peso di ogni guanto 4,9 grammi</p>  <p>NITRILE (blue) PowderFree , spessore 11 e+ micron</p> 					
22-88633 spessore 11 + micron	1 x100 pz	box	NITRILE Gloves mis. SMALL PowderFree , colore light-blue	6,50	
22-88633.x10	10 x100 pz	cartone orig.	idem come sopra / bulkcase	57,60	1.000 pezzi
22-88635 spessore 11 + micron	1 x100 pz	box	NITRILE Gloves mis. MEDIUM PowderFree , colore light-blue	6,50	
22-88635.x10	10 x100 pz	cartone orig.	idem come sopra / bulkcase	57,60	1.000 pezzi
22-88637 spessore 11 + micron	1 x100 pz	box	NITRILE Gloves mis. LARGE PowderFree , colore light-blue	6,50	
22-88637.x10	10 x100 pz	cartone orig.	idem come sopra / bulkcase	57,60	1.000 pezzi
22-88639 spessore 11 + micron	1 x100 pz	box	NITRILE Gloves mis. Extra-LARGE PowderFree , colore light-blue	6,50	
22-88639.x10	10 x100 pz	cartone orig.	idem come sopra / bulkcase	57,60	1.000 pezzi
<p>EkoZ-PW NO LATEX GLOVES peso di ogni guanto 3,0 grammi</p>  <p>Eko-NITRILE (blue) PowderFree , spessore 9 micron/dita e 5 micron/palmo+polsino</p> 					
22-86633.x10 spessore 5 a 9 micron	10 x100 pz	cartone orig.	EkoZNITRILE Gloves mis. SMALL PowderFree , colore light-blue	46,20	1.000 pezzi
22-86635.x10 spessore 5 a 9 micron	10 x100 pz	cartone orig.	EkoZNITRILE Gloves mis. MEDIUM PowderFree , colore light-blue	46,20	1.000 pezzi
22-86637.x10 spessore 5 a 9 micron	10 x100 pz	cartone orig.	EkoZNITRILE Gloves mis. LARGE PowderFree , colore light-blue	46,20	1.000 pezzi
22-86639.x10 spessore 5 a 9 micron	10 x100 pz	cartone orig.	EkoZNITRILE Gloves mis. ExLARGE PowderFree , colore light-blue	46,20	1.000 pezzi
22-86645.x10 spessore 5 a 9 micron	10 x100 pz	5 small +5 medium	EkoZNITRILE Gloves mis. VARIE PowderFree , colore light-blue	47,40	1.000 pezzi
22-86647.x10 spessore 5 a 9 micron	10 x100 pz	4 s + 4 m +2 L	EkoZNITRILE Gloves mis. VARIE PowderFree , colore light-blue	47,40	1.000 pezzi
22-86649.x10 spessore 5 a 9 micron	10 x100 pz	3 s + 3 m 2 L + 2 xL	EkoZNITRILE Gloves mis. VARIE PowderFree , colore light-blue	47,40	1.000 pezzi

***PROMO ARTICOLI CONSUMO "2016-base"**

Validità promozione al 31-GENNAIO-2017

codice gamma 20-.....	confezione	tipo Confez.	Articolo	Prezzo Unit x Conf in Euro iva esclusa	Note
ANSE DISPOSABLE STERILI PIU' TIPI E MISURE					
					
20-0021601.x500	500 pz	x 1 pz/Sterili	Anse Sterili a T	49,00	
20-0021701.x500	500 pz	x 1 pz/Sterili	Anse Sterili ad L	49,00	
20-0021705.x500	500 pz	x 5 pz/Sterili	Anse Sterili ad L	36,00	
20-0021750.x500	500 pz	x20 pz/Sterili	Anse Sterili ad Anello 1 yl	20,00	
20-0021770.x500	500 pz	x20 pz/Sterili	Anse Sterili ad Anello 10 yl	20,00	
20-0021790.x990	1000 pz	x20 pz/Sterili	Anse Sterili a Punta	35,00	
BISTURI DISPOSABLE STERILI (imballo singolo) 3 MISURE					
20-0300510.x010	10 pz	x 1 pz/Sterili	Bisturidispo Sterili lama-10 Panc	6,00	
20-0300510.x100	100 pz	x 1 pz/Sterili	idem come sopra	48,00	
20-0300511.x010	10 pz	x 1 pz/Sterili	Bisturidispo Sterili lama-11 Retta	6,00	
20-0300511.x100	100 pz	x 1 pz/Sterili	idem come sopra	48,00	
20-0300522.x010	10 pz	x 1 pz/Sterili	Bisturidispo Sterili lama-22 Panc	6,00	
20-0300522.x100	100 pz	x 1 pz/Sterili	idem come sopra	48,00	
					
BUSTE PER STERILIZZAZIONE 3 MISURE					
					
20-0502130.x100	100 pz	unica	Buste Biohazard PP 21x30	18,00	(max. +121° C)
20-0502130.x500	500 pz	unica	idem come sopra // conf. bulk	81,00	
20-0502130.x900	1000 pz	unica	idem come sopra // maxi-bulk	144,00	
20-0502135	1 pz	===	Supporto da banco in metallo	14,00	
20-0604061.x250	250 pz	unica	Buste Biohazard PP 40x60	80,00	(max. +121° C)
20-0604061.x500	500 pz	unica	idem come sopra // conf. bulk	144,00	
20-0606076.x250	250 pz	unica	Buste Biohazard PP 60x76	119,00	(max. +121° C)
20-0606076.x500	500 pz	unica	idem come sopra // conf. bulk	214,20	



***PROMO ARTICOLI CONSUMO "2016-base"**

Validità promozione al 31-GENNAIO-2017

codice gamma 20-.....	confezione	tipo Confez.	Articolo	Prezzo Unit x Conf in Euro iva esclusa	Note
BEAKERS TRICORNO GRADUATI POLIPROPILENE TRASPARENTE-TRASLUCIDO					
					
20-0901802.x010	10 pz	unica	Beaker PP tricorno grad. ml. 50	4,60	
20-0901803.x010	10 pz	unica	Beaker PP tricorno grad. ml. 100	5,70	
20-0901805.x010	10 pz	unica	Beaker PP tricorno grad. ml. 250	7,10	
20-0901806.x010	10 pz	unica	Beaker PP tricorno grad. ml. 400	7,60	
20-0901808.x010	10 pz	unica	Beaker PP tricorno grad. ml.1000	12,30	
BEAKERS GRADUATI IN POLIPROPILENE ED IN TPX AUTOCLAVABILI					
					
20-0921802.x001	1 pz	Conf.	Beaker PP +becco grad. ml. 50	1,10	
20-0921802.x012	12 pz	bulk	Beaker PP +becco grad. ml. 50	(0,90) 10,80	
20-0921803.x001	1 pz	Conf.	Beaker PP +becco grad. ml. 100	1,20	
20-0921803.x012	12 pz	bulk	Beaker PP +becco grad. ml. 100	(0,96) 11,52	
20-0921805.x001	1 pz	Conf.	Beaker PP +becco grad. ml. 250	1,45	
20-0921805.x012	12 pz	bulk	Beaker PP +becco grad. ml. 250	(1,15) 13,80	
20-0921806.x001	1 pz	Conf.	Beaker PP +becco grad. ml. 500	2,50	
20-0921806.x012	12 pz	bulk	Beaker PP +becco grad. ml. 500	(2,00) 24,00	
20-0921808.x001	1 pz	Conf.	Beaker PP +becco grad. ml. 1000	4,80	
20-0921808.x004	4 pz	bulk	Beaker PP +becco grad. ml. 1000	(3,85) 15,40	
20-0921809.x001	1 pz	Conf.	Beaker PP +becco grad. ml. 2000	6,50	
20-0921809.x004	4 pz	bulk	Beaker PP +becco grad. ml. 2000	(5,20) 20,80	
20-0921812.x001	1 pz	Conf.	Beaker PP +becco grad. ml. 5000	20,00	
20-0921812.x002	2 pz	bulk	Beaker PP +becco grad. ml. 5000	(16,00) 32,00	
20-0941542.x001	1 pz	Conf.	Beaker TPX +becco grad. ml. 50	2,75	
20-0941542.x012	12 pz	bulk	Beaker TPX +becco grad. ml. 50	(2,20) 26,40	
20-0941543.x001	1 pz	Conf.	Beaker TPX +becco grad. ml. 100	21,00	
20-0941543.x012	12 pz	bulk	Beaker TPX +becco grad. ml. 100	(2,25) 27,00	
20-0941545.x001	1 pz	Conf.	Beaker TPX +becco grad. ml. 250	3,30	
20-0941545.x012	12 pz	bulk	Beaker TPX +becco grad. ml. 250	(2,65) 31,80	

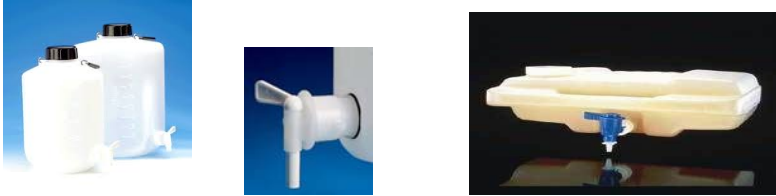

***PROMO ARTICOLI CONSUMO "2016-base"**

Validità promozione al 31-GENNAIO-2017

codice gamma 20-.....	confezione	tipo Confez.	Articolo	Prezzo Unit. x Conf in Euro iva esclusa	Note
20-0941546.x001	1 pz	Conf.	Beaker TPX +becco grad. ml. 500	6,70	
20-0941546.x012	12 pz	bulk	Beaker TPX +becco grad. ml. 500	(5,40) 64,80	
20-0941548.x001	1 pz	Conf.	Beaker TPX +becco grad. ml. 1000	8,40	
20-0941548.x004	4 pz	bulk	Beaker TPX +becco grad. ml. 1000	(6,75) 27,00	
20-0941549.x001	1 pz	Conf.	Beaker TPX +becco grad. ml. 2000	11,70	
20-0941549.x004	4 pz	bulk	Beaker TPX +becco grad. ml. 2000	(9,35) 37,40	
20-0941551.x001	1 pz	Conf.	Beaker TPX +becco grad. ml. 5000	29,00	
20-0941551.x002	2 pz	bulk	Beaker TPX +becco grad. ml. 5000	(23,20) 46,40	
BOTTIGLIONI IN HDPE E LAB-CARBOY IN HDPE CON RUBINETTO SCARICO					
					
12-1660.x001	1 pz	Conf.	Bottiglione HDPE lt. 5 +Rubinetto	10,40	
12-1662.x001	1 pz	Conf.	Bottiglione HDPE lt. 10 +Rubinetto	13,25	
12-1664.x001	1 pz	Conf.	Bottiglione HDPE lt. 25 +Rubinetto	27,40	
20-0994300	1 pz	Conf.	Flat Lab-carboy HDPE lt. 8 +Rub.	84,00	idem 2323-0008
CILINDRI GRADUATI IN POLIPROPILENE ED IN TPX AUTOCLAVABILI					
					
20-1001078.x001	1 pz	Conf.	Cilindro PP +becco grad. ml. 50	3,00	
20-1001078.x012	12 pz	bulk	Cilindro PP +becco grad. ml. 50	(2,40) 28,80	
20-1001079.x001	1 pz	Conf.	Cilindro PP +becco grad. ml. 100	3,50	
20-1001079.x012	12 pz	bulk	Cilindro PP +becco grad. ml. 100	(2,80) 33,60	
20-1001080.x001	1 pz	Conf.	Cilindro PP +becco grad. ml. 250	4,50	
20-1001080.x012	12 pz	bulk	Cilindro PP +becco grad. ml. 250	(3,60) 43,20	
20-1001081.x001	1 pz	Conf.	Cilindro PP +becco grad. ml. 500	5,80	
20-1001081.x006	6 pz	bulk	Cilindro PP +becco grad. ml. 500	(4,65) 27,90	
20-1001082.x001	1 pz	Conf.	Cilindro PP +becco grad. ml. 1000	9,00	
20-1001082.x006	6 pz	bulk	Cilindro PP +becco grad. ml. 1000	(7,20) 43,20	
20-1001094.x001	1 pz	Conf.	Cilindro PP +becco grad. ml. 2000	18,50	
20-1001094.x002	2 pz	bulk	Cilindro PP +becco grad. ml. 2000	(14,80) 29,60	
20-1001572.x012	12 pz	bulk	Cilindro TPX+becco grad. ml. 50	(3,90) 46,80	
20-1001573.x012	12 pz	bulk	Cilindro TPX+becco grad. ml. 100	(4,00) 48,00	
20-1001574.x012	12 pz	bulk	Cilindro TPX+becco grad. ml. 250	(6,40) 76,80	
20-1001575.x006	6 pz	bulk	Cilindro TPX+becco grad. ml. 500	(9,40) 56,40	
20-1001576.x006	6 pz	bulk	Cilindro TPX+becco grad. ml. 1000	(14,80) 88,20	
20-1001577.x002	2 pz	bulk	Cilindro TPX+becco grad. ml. 2000	(29,30) 58,60	



***PROMO ARTICOLI CONSUMO "2016-base"**

Validità promozione al 31-GENNAIO-2017

codice gamma 20-.....	confezione	tipo Confez.	Articolo	Prezzo Unit. x Conf in Euro iva esclusa	Note
					
20-1000500.x500	500 gr	unica	Cotone idrofilo zig-zag marca oro	5,00	
20-1000500.x510	5.000 gr	5 x1000 gr	idem come sopra // conf. bulk	40,00	
20-1000801.x905	5.000 gr	unica	Cotone Greggio Cardato IDROFOBO x Uso Batteriologico	52,00	
20-1000801.x955	55 Kg	2 x27,5 Kg		429,00	
CUVETTE DISPONIBILI PS E PMMA UV PER SPETTROFOTOMETRIA E FLUORIMETRIA					
					
20-1001940.x100	100 pz	1 x100 pz	Cuvette Semimicro PS HALF	8,00	visibile
20-1001940.x500	500 pz	5 x100 pz	Fino 2,5 ml. da 340 a 900 nm	34,00	
20-1001941.x100	100 pz	1 x100 pz	Cuvette Semimicro PMMA HALF	12,00	vicino UV
20-1001941.x500	500 pz	5 x100 pz	Fino 2,5 ml. da 280 a 800 nm	51,00	
20-1001960.x100	100 pz	1 x100 pz	Cuvette MACRO PS xFluorimetria	9,00	visibile
20-1001960.x500	500 pz	5 x100 pz	Fino 4,5 ml. da 340 a 900 nm	38,20	
20-1001961.x100	100 pz	1 x100 pz	Cuvette MACRO PMMA xFluorim.	12,00	vicino UV
20-1001961.x500	500 pz	5 x100 pz	Fino 4,5 ml. da 280 a 800 nm	51,00	
20-1005370.x100	100 pz	1 x100 pz	Cuvette MACRO PS ALTE	7,50	visibile
20-1005370.x500	500 pz	5 x100 pz	Fino 4,5 ml. da 340 a 900 nm	13,50	
20-1005390.x100	100 pz	1 x100 pz	Cuvette MACRO PMMA ALTE	13,50	vicino UV
20-1005390.x500	500 pz	5 x100 pz	Fino 4,5 ml. da 280 a 800 nm	57,40	
20-1005380.x100	100 pz	1 x100 pz	Cuvette Semimicro PS ALTE	9,00	visibile
20-1005380.x500	500 pz	5 x100 pz	Fino 1,5 ml. da 340 a 900 nm	38,20	
20-1005380.x100	100 pz	1 x100 pz	Cuvette Semimicro PMMA ALTE	14,00	vicino UV
20-1005380.x500	500 pz	5 x100 pz	Fino 1,5 ml. da 280 a 800 nm	52,50	
20-1107390.x100	100 pz	unica	Cuvette MACRO pieno UV ALTE	42,00	pieno UV
			Fino 4,5 ml. da 200 a 800 nm		
20-1107400.x100	100 pz	unica	Cuvette Semicro pieno UV HALF	46,00	pieno UV
			Fino 2,5 ml. da 200 a 800 nm		
20-1107500.x100	100 pz	unica	Spatoline PS disposable xCuvette	2,50	

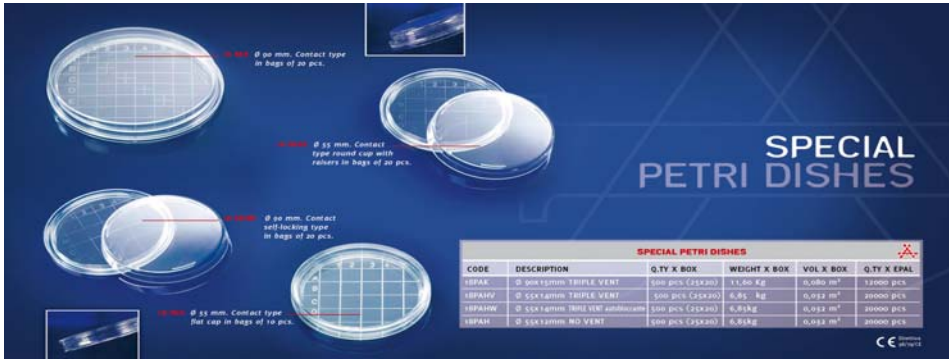

*PROMO ARTICOLI CONSUMO "2016-base"

Validità promozione al 31-GENNAIO-2017

codice gamma 20-.....	confezione	tipo Confez.	Articolo	Prezzo Unit. x Conf in Euro iva esclusa	Note
CAPSULE PETRI No-Vent , 3-Vent , E SPECIALI PER BATTERIOLOGIA					
					
20-140037.x800	800 pz	x20 pz/Sterili	Capsule Petri 3-vent d.mm. 35	124,00	
20-140062.x500	500 pz	x20 pz/Sterili	Capsule Petri no-vent d.mm. 60	54,00	
20-140067.x500	500 pz	x20 pz/Sterili	Capsule Petri 3-vent d.mm. 60	54,00	
20-140092.x500	500 pz	x20 pz/Sterili	Capsule Petri no-vent d.mm. 92	58,00	
20-140097.x500	500 pz	x20 pz/Sterili	Capsule Petri 3-vent d.mm. 92	58,00	
20-1400107.x460	460 pz	x20 pz/Sterili	Capsule Petri 3-vent d.mm. 100	94,00	
20-1400122.x240	240 pz	x20 pz/Sterili	Capsule Petri no-vent d.mm. 120	62,50	ad esaurimento
20-1400122.x320	320 pz	x20 pz/Sterili	Capsule Petri no-vent d.mm. 120	83,30	ad esaurimento
20-1400157.x220	220 pz	x20 pz/Sterili	Capsule Petri 3-vent d.mm. 150	90,00	Conf. revised
20-1400210.x500	500 pz	x10 pz/Sterili	Capsule Petri 4-vent Quadre misura mm. 100 x 100 x 15 h. Grid interno (6x6) = 36 Quadratini ogni ri-quadro 13 x 13mm	on request	Prezzo net(242) Non scontabile
20-1400222.x180	180 pz	x20 pz/Sterili	Capsule Petri no-vent Quadre misura mm. 122 x 122	76,00	Conf. revised
					
20-1400555.x500	500 pz	x20 pz/Sterili	Capsule Petri PS "55-Contact" diam. mm. 55 con griglia serigrafata indelebile sul fondo	98,00	no vent / Flat Lid
20-1400595.x500	500 pz	x20 pz/Sterili	Capsule Petri PS "90-Contact" diam. mm. 90 con griglia serigrafata indelebile sul fondo	102,00	no vent / Flat Lid



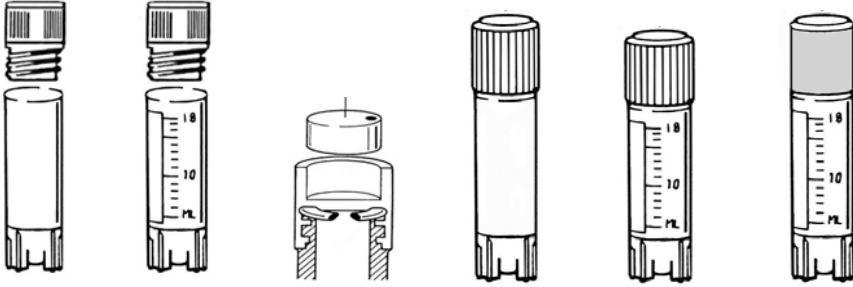

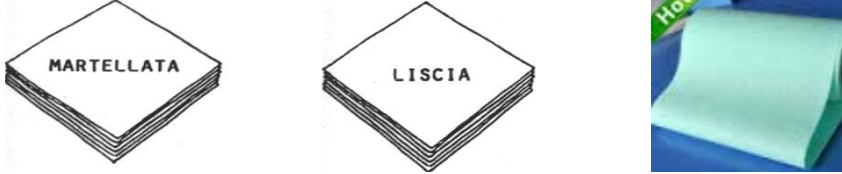
***PROMO ARTICOLI CONSUMO "2016-base"**

Validità promozione al 31-GENNAIO-2017

codice gamma 20-.....	confezione	tipo Confez.	Articolo	Prezzo Unit. x Conf in Euro iva esclusa	Note
CRYOVIALS STERILI Rnase-Dnase Free UTILIZZABILI A -86°C ... fino -190°C					
 <p style="text-align: right;">SLIM-11</p>					<p>Tutte con tappo vite completo di o-Ring silconico di tenuta.</p> <p>Utilizzo anche nel vapor-phase dello Azoto liquido fino a -192° C</p>
20-1460400.x500	500 pz	x100 pz/Sterili	CryoVials Skirted lisce ml. 2,0	75,00	avvitatura interna
20-1462400.x500 corpo esterno 12,5 mm	500 pz	x100 pz/Sterili	CryoVials Skirted graduate ml. 2,0	91,00	avvitatura interna
20-1470400.x500	500 pz	x100 pz/Sterili	CryoVials Skirted lisce ml. 2,0	75,00	avvitatura esterna
20-1472400.x500 corpo esterno 12,5 mm	500 pz	x100 pz/Sterili	CryoVials Skirted graduate ml. 2,0	91,00	avvitatura esterna
20-1482400.x500 corpo esterno 11,2 mm	500 pz	x100 pz/Sterili	CryoVials Skirted graduate ml.2,0 (diam. mm. 11,2) Extra-SLIM	91,00	avvitatura esterna
20-1480078.x500	500 pz		Disk Inserts Alti "formato Stella"	18,00	
20-1480085.x012	12 pz		CryoCANE alluminio, lungh. 290 mm.	20,00	
20-1480210.x100	100 pz		CryoSleeve PVC x Cane	60,00	
20-1481001.x001	1 pz		Porta-Cryovials PP bleu a 50 posti con sistema autobloccante	14,00	
20-1481001.x010	10 pz		idem come sopra // conf. bulk	126,00	
					
					
20-1504018.x100	100 fogli	1 x100 fogli	Carta filtro/banco Martellata	8,40	
20-1504018.x500	500 fogli	1 x500 fogli	formato cm. 50 x50 (67 gr/mq)	37,80	
20-1504020.x100	100 fogli	1 x100 fogli	Carta filtro/banco Liscia-Liscia	8,40	
20-1504020.x500	500 fogli	1 x500 fogli	formato cm. 50 x50 (65 gr/mq)	37,80	
20-1505050.x100	100 fogli	unica piana	Carta crespa verdina cm. 50 x50	16,00	
20-1505050.x500	500 fogli		x Sterilizzazione (60 gr/mq)	56,00	
20-1505100.x050	50 fogli	unica piegata	Carta crespa verdina cm. 100x100	32,00	
20-1505100.x250	250 fogli		x Sterilizzazione (60 gr/mq)	112,00	

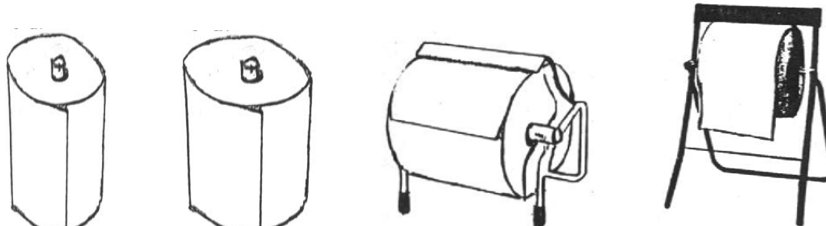
*PROMO ARTICOLI CONSUMO "2016-base"

Validità promozione al 31-GENNAIO-2017

codice gamma 20-.....	confezione	tipo Confez.	Articolo	Prezzo Unit. x Conf in Euro iva esclusa	Note
				20-1511200  20-1511210	
20-1506060.x012	12 roll	12 x 1 roll	Asciugatutto Pura-Cell- 60 metri, devolgimento anche a spirale interna	24,00	<i>devolgimento a spirale interna</i>
20-1506200.x006	6 roll	6 x 1 roll (480+ strappi)	Asciugatutto Pura-Cell- 180 metri devolgimento std-esterno	30,60	
20-1506991.x002	2 roll	2 x 1 roll (800+ strappi)	Asciugatutto Pura-Cell- 800x0,25 cm devolgimento std-esterno	14,00	
20-1506996.x001	1 roll	2 x 1 roll (2000+ strappi)	Asciugatutto Pura-Cell 2000x0,25cm devolgimento std-esterno	21,00	
20-1507005	1 pz	unica	Supporto Banco o Parete per tutti, escluso 2000 Strappi	22,00	
20-1507007	1 pz	unica	Supporto da terra per tutti con cavalletto	28,00	
20-1509100	1 pz	unica	Sapone Liquido pH-neutro	2,80	
20-1509100.x010	10 pz	10 x1 pz	Sapone Liquido pH-neutro	25,20	
20-1509115.x010	10 pz	10 x1 ricarica	Ricarica Sap. Liquido pH-neutro	21,60	
20-1511200	50 ff	unica/fogli	Carta banco cm.46x57 190gr/mq	29,00	lato politenato
20-1511200.x300	300 ff	6 x 50 fogli	idem come sopra // conf. bulk	156,60	lato politenato
20-1511210	50 ff	unica/fogli	Carta banco cm.50x80 85gr/mq	28,00	lato blu politenato
20-1511210.x300	300 ff	6 x 50 fogli	idem come sopra // conf. bulk	151,20	lato blu politenato
20-2005010	1 litro	unica-LM-1	DETERGENTE LM-1 Neutracon pH 7,00 Biodegradabile per Pulizia metalli non ferrosi, Vetro, Polimeri, etc.	16,50	
20-2005010.x905	5 litri	unica-LM-1	idem come sopra /conf.bulk	57,75	
20-2005050	1 litro	unica-LM-2	DETERGENTE LM-2 DECON-90 Il più utilizzato, anche come decontaminante. Sostituisce la Miscela Solfocromica	17,50	
20-2005050.x905	5 litri	unica-LM-2	idem come sopra /conf.bulk	61,25	
20-2533120	50 pz	x 1 pz/ Sterili	Filtri MCE 0,22 micron diam.mm.33	52,00	
20-2533145	50 pz	x 1 pz/ Sterili	Filtri MCE 0,45 micron diam.mm.33	50,00	

***PROMO ARTICOLI CONSUMO "2016-base"**



Validità promozione al 31-GENNAIO-2017

codice gamma 20-.....	confezione	tipo Confez.	Articolo	Prezzo Unit. x Conf in Euro iva esclusa	Note
20-3399050	1 x 50 gr.	tubetto	Dow-Corning Grasso Silicone per Alto Vuoto	18,00	
20-4418000.x010	1 x 10 pz	unica	Capsule deodoranti xAutoclave	12,00	
20-4418000.x050	1 x 50 pz	unica	idem come sopra	48,00	
20-4418420.x001 qualità extra	1 x 1 roll	unica	Indicatore Roll mm.19 x50 metri x Sterilizz. in Autoclave (STEAM)	4,00	
20-4418420.x010	1 x 10 roll	unica	idem come sopra /conf.bulk	36,00	
20-4418426.x001 qualità extra	1 x 1 roll	unica	Indicatore Roll mm.19 x50 metri x Sterilizz. a Secco (Poupinel)	16,50	
20-4418426.x005	1 x 5 roll	unica	idem come sopra /conf.bulk	66,00	

x



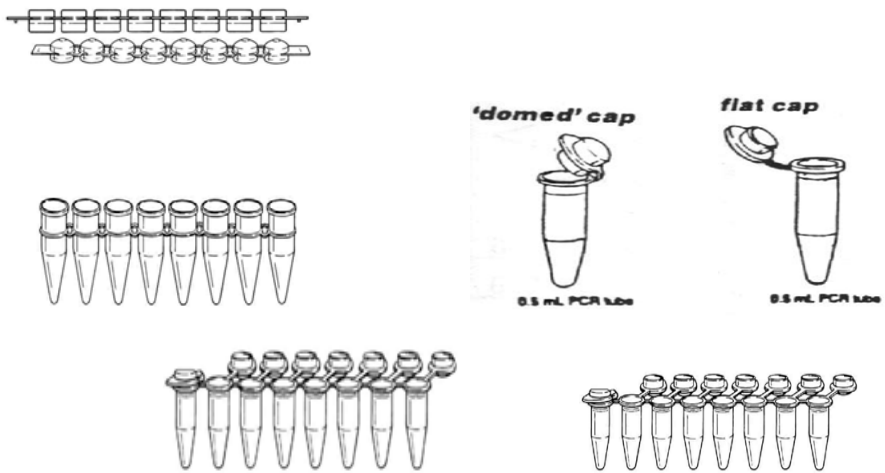

***PROMO ARTICOLI CONSUMO "2016-base"**

Validità promozione al 31-GENNAIO-2017

codice gamma 20-.....	confezione	tipo Confez.	Articolo	Prezzo Unit. x Conf in Euro iva esclusa	Note
MICROTUBI CONICI ... PCR 0,2 E 0,5 ml. / + / MICROTUBI 0,5 - 1,5 E 2,0 ml.					
					
STRIPS SPECIALI per RotorGene-6000					
20-4710020.x905	5000 pz	5 x 1000 pz	UniQlty PCR-tubes 0,2 Domedcap	120,00	qualità routine
20-4710040.x905	5000 pz	5 x 1000 pz	UniQlty PCR-tubes 0,2 FLAT-cap	120,00	qualità routine
20-5010005	1000 pz	125 x 8 pz	UniTH Strips 8-Flat-optical-cap	20,00	qualità superiore
20-5010008	1000 pz	125 x 8 pz	UniTH Strips 8-Domed-cap	20,00	qualità superiore
20-5010020	1000 pz	Clear-tubes	UniTH PCR-tubes 0,2 Domed-cap	51,00	qualità superiore
20-5010022	1000 pz	x100 pz/Sterili	UniTH PCR-tubes 0,2 Domed-cap	59,00	qualità superiore
20-5010040	1000 pz	Clear-tubes	UniTH PCR-tubes 0,2 FLAT-cap	41,00	qualità superiore
20-5010042	1000 pz	x100 pz/Sterili	UniTH PCR-tubes 0,2 FLAT-cap	49,00	qualità superiore
20-5010045	1000 pz	4 colori ass.ti	UniTH PCR-tubes 0,2 FLAT-cap	48,00	

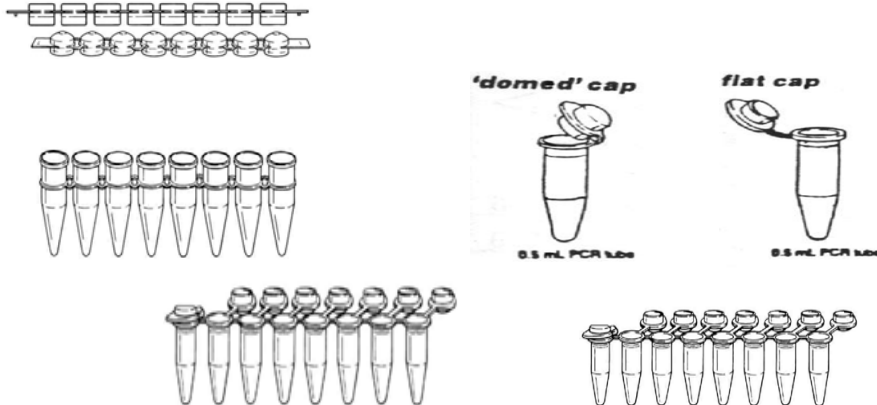
*PROMO ARTICOLI CONSUMO "2016-base"

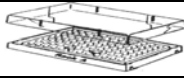
Validità promozione al 31-GENNAIO-2017

codice gamma 20-.....	confezione	tipo Confez.	Articolo	Prezzo Unit. x Conf in Euro iva esclusa	Note
20-5010060	1000 pz	125 x 8 pz std-profile	UniTH Strip 8-Clear-Tubes 0,2 ml senza Strip tappini	73,50	Std-Quality
20-5010070	960 pz	120 x 8 pz std-profile	UniTH Strip 8-Clear-Tubes 0,2 ml + separate 8-FLAT optical-caps	80,00	Std-Quality
20-5010072 sterili irradiate	960 pz	120 x 8 pz std-profile	UniTH Strip 8-Clear-Tubes 0,2 ml + separate 8-FLAT optical-caps	88,00	Std-Quality sterili
20-5010080	960 pz	120 x 8 pz std-profile	UniTH Strip 8-Clear-Tubes 0,2 ml + separate 8-Domed -caps strip	80,00	Std-Quality
20-5010082 sterili irradiate	960 pz	120 x 8 pz std-profile	UniTH Strip 8-Clear-Tubes 0,2 ml + separate 8-Domed -caps strip	88,00	Std-Quality sterili
20-5010116	960 pz	120 x 8 pz low-profile	UniTH Strip 8-Clear-Tubes 0,2 ml + single/attached FLAT-opt.-cap	78,00	Std-Quality
				 <p>STRIPS SPECIALI per RotorGene-6000</p>	
20-5011880	1000 pz	250 x 4 pz special-profile	UniTH Strip 4-Clear-Tubes 0,1 ml + separate Strip 4-attached-cap	*131,40	STRIPS SPECIALI per RotorGene-6000
20-5011880.x905	5000 pz	1250 x 4 pz	...per RotorGene6000 // Quiagen	*591,30	
20-5012070	960 pz	120 x 8 pz low-profile	UniTH Strip 8-Clear-Tubes 0,2 ml + separate 8-FLAT optical-caps	80,00	HPE-Quality
20-5012074	960 pz	120 x 8 pz low-profile	UniTH Strip 8-WhiteTubes 0,2 ml + separate 8-FLAT optical-caps	84,00	HPE-Quality
20-5012470	960 pz	120 x 8 pz std-profile	UniTH Strip 8-Clear-Tubes 0,2 ml + single/attached FLAT-opt.-cap	78,00	HPE-Quality
20-5012474	960 pz	120 x 8 pz std-profile	UniTH Strip 8-WhiteTubes 0,2 ml + single/attached FLAT-opt.-cap	82,00	HPE-Quality
20-5012480	960 pz	120 x 8 pz low-profile	UniTH Strip 8-Clear-Tubes 0,2 ml + single/attached FLAT-opt.-cap	80,00	HPE-Quality
20-5012484	960 pz	120 x 8 pz low-profile	UniTH Strip 8-WhiteTubes 0,2 ml + single/attached FLAT-opt.-cap	84,00	HPE-Quality
20-7510220.x005 20-7510220.x020	5 pz 20 pz	unica 4 x5 pz	PCR RACKS PP 96 x 0,2 ml. con coperchio " poggiato "	36,00 129,60	
20-7510222.x005 20-7510222.x005	5 pz 20 pz	unica 4 x5 pz	PCR RACKS PP 96 x 0,2 ml. con coperchio " incernierato "	30,00 96,00	
20-7510224.x005 20-7510224.x020	5 pz 20 pz	unica 4 x5 pz	PCR RACKS PP 96 x 0,2 ml. con coperchio " sicurezza "	40,00 144,00	

***PROMO ARTICOLI CONSUMO "2016-base"**

Validità promozione al 31-GENNAIO-2017

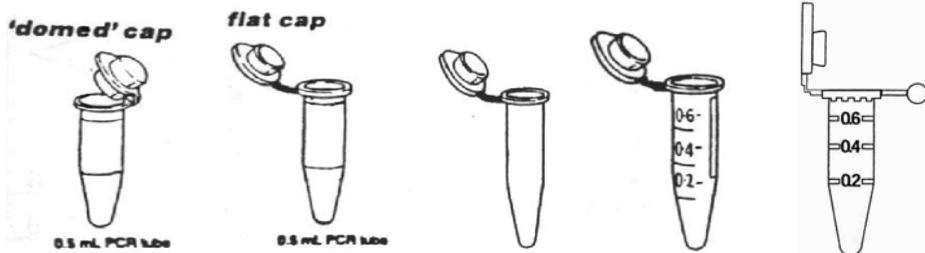
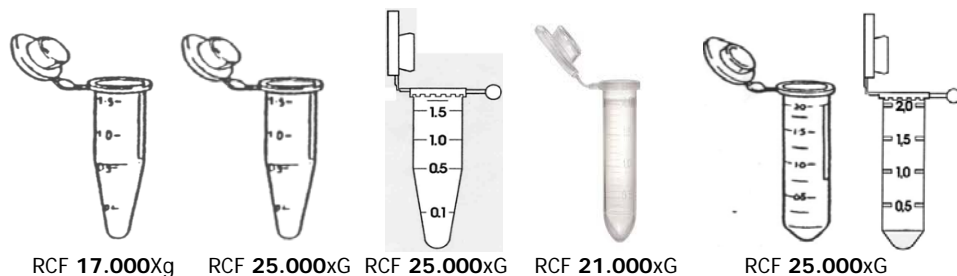

codice gamma 20-.....	confezione	tipo Confez.	Articolo	Prezzo Unit. x Conf in Euro iva esclusa	Note
					MICROTUBI CONICI 0,5 ml.
20-5010450	1000 pz	Clear-tubes	UniTH PCR-tubes 0,5 FLAT-cap	42,00	Thin-wall quality
20-5010455	1000 pz	4 colori ass.ti	UniTH PCR-tubes 0,5 FLAT-cap	49,00	Thin-wall quality
20-5010510 20-5010510.x905	1 x 1000 pz 5 x 1000 pz	RCF 17.000xG	UniMicrotubi 0,5 ml. Flatcap-cavo	6,50 29,25	Routine-quality
20-5010630.x900 20-5010630.x905	1 x 1000 pz 5 x 1000 pz	RCF 25.000xG	UniMtubi grad. 0,5 ml. FLAT-cap	18,00 80,00	XTRA-quality *Rnase-Dnase free
20-5010805 20-5010805.x505	1 x 500 pz 5 x 500 pz	RCF 25.000xG	UniMtubi grad. 0,5 ml. FLAT-cap	16,00 72,00	High-quality +chiusura secur
					MICROTUBI CONICI 1,5 ml. 2,0 ml. 5,0 ml.
20-5015006.x900 20-5015006.x905	1 x 1000 pz 5 x 1000 pz	RCF 17.000xG	UniMtubi grad. 1,5 ml. FLAT-cap	7,90 35,20	Routine-quality ex 20-5015007
20-5015012.x900 20-5015012.x905	2 x 500 pz 10 x 500 pz	RCF 25.000xG	UniMtubi grad. 1,5 ml. FLAT-cap	12,60 56,00	High-quality ex 20-5015015
20-5015022.x900 20-5015022.x905	2 x 500 pz 10 x 500 pz	RCF 25.000xG	UniMtubi grad. 1,5 ml. FLAT-cap	16,20 72,00	High-quality *Rnase-Dnasefree
20-5015030.x900 20-5015030.x905	2 x 500 pz 10 x 500 pz	RCF 25.000xG	UniMtubi grad. 1,5 ml. FLAT-cap	22,50 100,00	XTRA-quality *Rnase-Dnasefree
20-5015815 20-5015815.x905	1 x 1000 pz 5 x 1000 pz	RCF 25.000xG	UniMtubi grad. 1,5 ml. FLAT-cap	*26,10 *116,00	High-quality +chiusura secur
20-5020200.x900 20-5020200.x905	1 x 1000 pz 5 x 1000 pz	RCF 21.000xG	UniMtubi grad. 2,0 ml. FLAT-cap	15,00 67,50	Routine-quality ex 20-5020202
20-5020290.x900 20-5020290.x905	2 x 500 pz 10 x 500 pz	RCF 25.000xG	UniMtubi grad. 2,0 ml. FLAT-cap	27,00 120,00	XTRA-quality *Rnase-Dnasefree
20-5020820 20-5020820.x905	1 x 1000 pz 5 x 1000 pz	RCF 25.000xG	UniMtubi grad. 2,0 ml. FLAT-cap	*36,00 *160,00	High-quality +chiusura secur
20-5022350.x200 20-5022350.x900	1 x 200 pz 5 x 200 pz	RCF 30.000xG	UniMtubi grad. 5,0 ml. FLAT-cap	29,00 116,00	XTRA-quality *Rnase-Dnasefree

***PROMO ARTICOLI CONSUMO "2016-base"** Validità promozione al 31-GENNAIO-2017

codice	confezione	tipo Confez.	Articolo	Prezzo Unit. x Conf in Euro iva esclusa	Note
MICROTUBI CONICI-CONICI E CONICI-SKIRTED CAPACITA' 0,5 ml. / 1,5 ml. e 2,0 ml. CON COLLO A VITE E TAPPI VITE CON O-RING TENUTA RCF max. 20.000 xG					
ANCHE PER CONSERVAZIONE CAMPIONI fino a -86 °C IN ULTRAFREEZERS (ED ALL' OCCORRENZA, NEL VAPOR PHASE DELL'AZOTO LIQUIDO a -190 °C)					
20-5024050 <i>ASEPTIC</i>	1 x 500 pz	conici-conici RCF 20.000xG	UniTH screwtubes 0,5 collo vite (tappini da acquistare a parte)	28,00	XTRA-quality *Rnase-DnaseFree <i>ASEPTIC</i>
20-5024052	1 x 500 pz	conici-skirted		28,00	
20-5024151 <i>ASEPTIC</i>	1 x 500 pz	conici-conici RCF 20.000xG	UniTH screwtubes 1,5 collo vite (tappini da acquistare a parte)	26,00	XTRA-quality *Rnase-DnaseFree <i>ASEPTIC</i>
20-5024152	1 x 500 pz	conici-skirted		26,00	
20-5024201 <i>ASEPTIC</i>	1 x 500 pz	conici-conici RCF 20.000xG	UniTH screwtubes 2,0 collo vite (tappini da acquistare a parte)	26,00	XTRA-quality *Rnase-DnaseFree <i>ASEPTIC</i>
20-5024203	1 x 500 pz	conici-skirted		26,00	
20-5024300 <i>ASEPTIC</i>	1 x 500 pz	con Loop RCF 20.000xG	ScrewCaps UniTH con o-Ring (tappini da acquistare a parte)	52,00	tappi con Loop *Rnase-DnaseFree
20-5024400	1 x 500 pz	senza Loop		52,00	tappisenzaLoop
20-5025050 <i>conici-conici</i>	5 x 100 pz	Sterili-.gamma +tappo Loop	UniTH screwtubes 0,5 collo vite STERILI con tappini avvitati	114,00	
20-5025052 <i>conici-skirted</i>	5 x 100 pz	Sterili-.gamma +tappo Loop	UniTH screwtubes 0,5 collo vite STERILI con tappini avvitati	114,00	
20-5025151 <i>conici-conici</i>	5 x 100 pz	Sterili-.gamma +tappo Loop	UniTH screwtubes 1,5 collo vite STERILI con tappini avvitati	114,00	
20-5025152 <i>conici-skirted</i>	5 x 100 pz	Sterili-.gamma +tappo Loop	UniTH screwtubes 1,5 collo vite STERILI con tappini avvitati	114,00	
20-5025201 <i>conici-conici</i>	5 x 100 pz	Sterili-.gamma +tappo Loop	UniTH screwtubes 2,0 collo vite STERILI con tappini avvitati	114,00	
20-5025203 <i>conici-skirted</i>	5 x 100 pz	Sterili-.gamma +tappo Loop	UniTH screwtubes 2,0 collo vite STERILI con tappini avvitati	114,00	

***PROMO ARTICOLI CONSUMO "2016-base"**

Validità promozione al 31-GENNAIO-2017

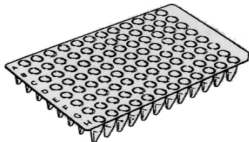
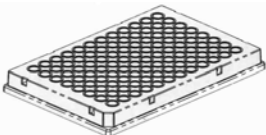
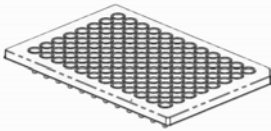

codice gamma 20-.....	confezione	tipo Confez.	Articolo	Prezzo Unit. x Conf in Euro iva esclusa	Note
					Etichette utilizzabili a basse temperature -86° C e ad Alte temperature +100° C
	TAGS-STATION		ETICHETTE per MicroTUBI per Provette		
20-5016002	1200 pz	White	UniTags mm. 27 x 9 alt.	26,40	per 0,2 e 0,5 ml.
20-5016004	1200 pz	Pink	UniTags mm. 27 x 9 alt.	26,40	per 0,2 e 0,5 ml.
20-5016115	1000 pz	White	UniTags mm. 32 x 13 alt.	22,00	per 1,5 e 2,0 ml.
20-5016119	1000 pz	Yellow	UniTags mm. 32 x 13 alt.	22,00	per 1,5 e 2,0 ml.
20-5016250.x905	5000 pz	colorati	Bollini adesivi diam. mm. 9,5	75,00	per 1,5 e 2,0 ml.
20-5016250.x925	25.000 pz	colorati	Bollini adesivi diam. mm. 9,5	300,00	per 1,5 e 2,0 ml.
20-5016610	1000 pz	White	UniTags mm. 37 x 18 alt.	24,00	per Falcon 15 ml.
20-5016614	1000 pz	Green	UniTags mm. 37 x 18 alt.	24,00	per Falcon 15 ml.
20-5016650	1000 pz	White	UniTags mm. 62 x 18 alt.	32,00	per Falcon 50 ml.
20-5016659	1000 pz	Yellow	UniTags mm. 62 x 18 alt.	32,00	per Falcon 50 ml.
20-5016900	1 pz	colorata bleu	TAGS-STATION per alloggiare i pacchetti di Etichette Uni-Tags	84,00	

PCR & q-PCR PLATES per PCR END-POINT & PCR REAL-TIMECONSULTARE – RICHIEDERE **Schede Tecniche PCR Plates UNIDISP** per **COMPARAZIONE** con ALTRE IN COMMERCIO
INFORMAZIONI SU COMPATIBILITA' CON I THERMAL-CYCLERS IN COMMERCIO

					
	5133000.....		5134410.....		5134500.....
20-5134000.x050	50 pz	Clear-96 well std-profile	PCR Plates UnSkirted Flat-top	125,00	anche White-cell
20-5134410.x050	50 pz	Clear-96 well low-profile	PCR Plates FullSkirted	140,00	anche White-cell
20-5134500.x050	50 pz	Clear-96 well std-profile	PCR Plates Semiskirted	140,00	anche White-cell



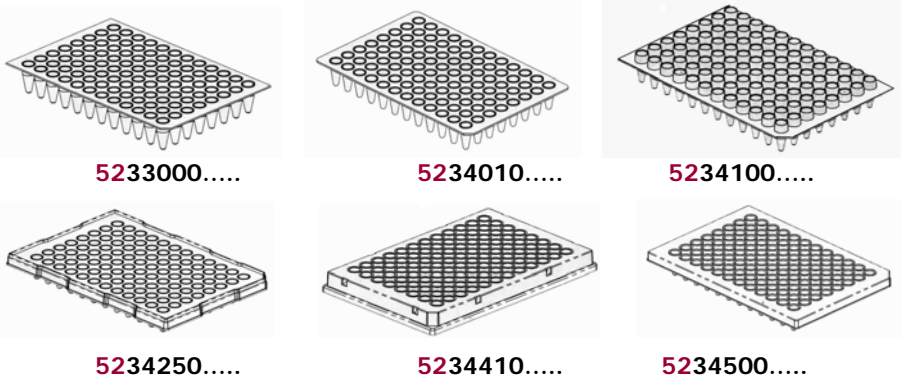

***PROMO ARTICOLI CONSUMO "2016-base"**

Validità promozione al 31-GENNAIO-2017

codice	confezione	tipo Confez.	Articolo	Prezzo Unit. x Conf in € iva esclusa	Note
CONSULTARE – RICHIEDERE Schede Tecniche PCR Plates UNIDISP per COMPARAZIONE con ALTRE IN COMMERCIO INFORMAZIONI SU COMPATIBILITA' CON I THERMAL-CYCLERS IN COMMERCIO					
					
20-5233000.x100	100 pz	Clear-96 well std-profile	PCR Plates UnSkirted Flat-top	306,00	
20-5234004.x100	100 pz	White-96 well	idem come sopra in White	324,00	
20-5234010.x100	100 pz	Clear-96 well low-profile	PCR Plates UnSkirted Flat-top	306,00	
20-5234014.x100	100 pz	White-96 well	idem come sopra in White	324,00	
20-5234100.x100	100 pz	Clear-96 well chimney-prof	PCR Plates UnSkirted Chimney-top	306,00	
20-5234250.x100	100 pz	Clear-96 well std-profile	PCR Plates SemiSkirted	306,00	
20-5234254.x100	100 pz	White-96 well	idem come sopra in White	324,00	
20-5234260.x100	100 pz	Clear-96 well low-profile	PCR Plates SemiSkirted	306,00	xABI Fast
20-5234264.x100	100 pz	White-96 well	idem come sopra in White	324,00	xABI Fast
20-5234300.x100	100 pz	Clear-384well 384-profile	PCR Plates FullSkirted	423,00	
20-5234314.x100	100 pz	White-96 well	idem come sopra in White	453,60	
20-5234350.x100	100 pz	Clear-384well 384-profile	PCR Plates FullSkirted	423,00	
20-5234354.x100	100 pz	White-96 well	idem come sopra in White	453,60	
20-5234410.x100	100 pz	Clear-96 well low-profile	PCR Plates FullSkirted	306,00	
20-5234414.x100	100 pz	White-96 well	idem come sopra in White	324,00	
20-5234500.x100	100 pz	Clear-96 well std-profile	PCR Plates SemiSkirted	306,00	
20-5234504.x100	100 pz	White-96 well	idem come sopra in White	324,00	
20-5234550.x100	100 pz	Clear-96 well low-profile	PCR Plates SemiSkirted	306,00	xRoche LC-480
20-5234554.x100	100 pz	White-96 well	idem come sopra in White	324,00	xRoche LC-480
ACCESSORI DEDICATI per PCR Plates (tutte) :					
20-5010005	1000 pz	125 x 8 pz	UniTH Strips 8-Flat-optical-cap	20,00	
20-5110390.x100	100 pz	Fogli adesivi	Pellicole ALLUMINIO Adesive	60,00	Std-grade
20-5110393.x100	100 pz	Fogli adesivi	Pellicole Adesive Poliolefina HQ	88,00	High-grade
20-5111392.x100	100 pz	Fogli adesivi	Pellicole Adesive OTTICHE HQ	175,00	optical grade

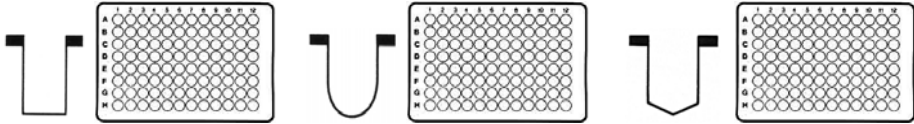

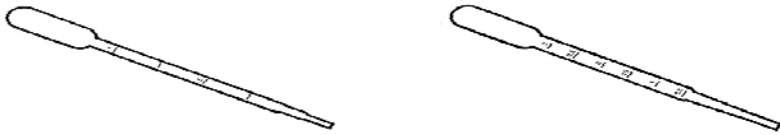
*PROMO ARTICOLI CONSUMO "2016-base"

Validità promozione al 31-GENNAIO-2017

codice gamma 20-.....	confezione	tipo Confez.	Articolo	Prezzo Unit. x Conf in Euro iva esclusa	Note
PIASTRE MICROTITER PS ASEPTIC E STERILI-IRRADIATE					
					
20-6618200.x300	300 pz/aseptic	6 x50 pz	MicroTiter PS 96-Flat asettiche	116,00	FONDO FLAT piatto
20-6618210.x300	300 pz/aseptic	6 x50 pz	MicroTiter PS 96- U asettiche	113,00	FONDO ROUND U
20-6618220.x300	300 pz/aseptic	6 x50 pz	MicroTiter PS 96- V asettiche	113,00	FONDO CONICO V
20-6618230.x300	300 pz/aseptic	6 x50 pz	Coperchi x MicroTiter asettici	83,40	
20-6618300.x050	50 pz/ Sterili	50 x1 pz	MicroTiter PS 96-Flat Sterili IW	22,50	FONDO FLAT piatto
20-6618300.x300	300 pz/ Sterili	300 x1 pz	idem come sopra//bulk-Sterili IW	121,50	FONDO FLAT piatto
20-6618310.x300	50 pz/ Sterili	50 x1 pz	MicroTiter PS 96- U Sterili IW	22,00	FONDO ROUND U
20-6618310.x050	300 pz/ Sterili	300 x1 pz	idem come sopra//bulk-Sterili IW	118,80	FONDO ROUND U
20-6618320.x300	50 pz/ Sterili	50 x1 pz	MicroTiter PS 96- V Sterili IW	22,00	FONDO CONICO V
20-6618320.x050	300 pz/ Sterili	300 x1 pz	idem come sopra//bulk-Sterili IW	118,80	FONDO CONICO V
20-6618330.x300	50 pz/ Sterili	50 x1 pz	Coperchi xMicroTiter Sterili IW	16,00	
20-6618330.x050	300 pz/ Sterili	300 x1 pz	idem come sopra//bulk-Sterili IW	86,40	
PIPETTE PASTEUR PET DISPOSABLE ASEPTIC E STERILI-IRRADIATE					
					
20-6618510.x500	500 pz	1x500 asettica	Pipette Pasteur PET grad. ml. 1,0	10,00	
20-6618510.x506	3.000 pz	6x500 asettiche	idem come sopra // conf. Bulk	51,00	
20-6618515.x900	1.000 pz	x 1 pz/Sterili	idem come sopra // Sterili I.W.	72,00	
20-6618510.x500	500 pz	1x500 asettica	Pipette Pasteur PET grad. ml. 1,0	10,00	
20-6618510.x506	3.000 pz	6x500 asettiche	idem come sopra // conf. Bulk	51,00	
20-6618515.x900	1.000 pz	x 1 pz/Sterili	idem come sopra // Sterili I.W.	72,00	
PIPETTE PASTEUR VETRO NEUTRO tipi Short + Long + ExtraLong					
					
	short cm. 15	Long cm. 23	ExtraLong cm. 27		Tettine puro lattice
20-6709150.x250	1 x 250 pz	Box-250	Pipette Pasteur vetro, short cm. 15	*9,90	
20-6709150.x900	4 x 250 pz	Box1000/bulk		*31,68	
20-6709230.x250	1 x 250 pz	Box-250	Pipette Pasteur vetro, long cm. 23	*10,80	
20-6709230.x900	4 x 250 pz	Box1000/bulk		*34,56	
20-6709270.x250	1 x 250 pz	Box-250	Pipette Pasteur vetro, Ex-long cm. 27	*15,30	
20-6709270.x900	4 x 250 pz	Box1000/bulk		*48,96	
20-8827830.x010	10 pz	Bustina	Tettine puro lattice tipo oliva	3,10	xPipette Pasteur
20-8827830.x100	100 pz	Bustina		24,80	



*PROMO ARTICOLI CONSUMO "2016-base"

Validità promozione al 31-GENNAIO-2017

codice gamma 20-.....	confezione	tipo Confez.	Articolo	Prezzo Unit. x Conf in Euro iva esclusa	Note
					
PIPETTE PS MONOUSO IN POLISTIRENE BIOLOGICAMENTE INERTE MODELLI ASEPTIC NON STERILI					
20-6691001.x500	500 pz/aseptic	unica	capacità ml. 1 1/100 aseptic	50,00	esaurimento
20-6691002.x500	500 pz/aseptic	unica	capacità ml. 2 1/100 aseptic	58,00	esaurimento
20-6691005.x200	200 pz/aseptic	unica	capacità ml. 5 1/10 aseptic	28,00	esaurimento
20-6691010.x200	200 pz/aseptic	unica	capacità ml. 10 1/10 aseptic	34,00	esaurimento
20-6691025.x200	200 pz/aseptic	unica	capacità ml. 25 2/10 aseptic	60,00	esaurimento
20-6691050.x100	100 pz/aseptic	unica	capacità ml. 50 5/10 aseptic	54,00	esaurimento
					
PIPETTE PS MONOUSO IN POLISTIRENE BIOLOGICAMENTE INERTE PER SIEROLOGIA E PER COLTURE CELLULARI MODELLI STERILI IRRADIATI IMBALLO SINGOLO PAPER-PLASTIC RNASE DNASE PYROGENS & ATP FREE					
20-6694001.x500	500 pz/sterili	IW/unica	capacità ml. 1 1/100 sterili/IW	58,00	TPP-400pz (58,50)
20-6694002.x500	500 pz/sterili	IW/unica	capacità ml. 2 1/100 sterili/IW	66,00	TPP-300pz (47,00)
20-6694005.x200	200 pz/sterili	IW/unica	capacità ml. 5 1/10 sterili/IW	32,00	TPP-200pz (53,00)
20-6694010.x200	200 pz/sterili	IW/unica	capacità ml. 10 1/10 sterili/IW	38,00	TPP-200pz (56,00)
20-6694025.x200	200 pz/sterili	IW/unica	capacità ml. 25 2/10 sterili/IW	64,00	TPP-100pz (52,00)
20-6694050.x100	100 pz/sterili	IW/unica	capacità ml. 50 2/10 sterili/IW	58,00	TPP- 50pz (48,00)

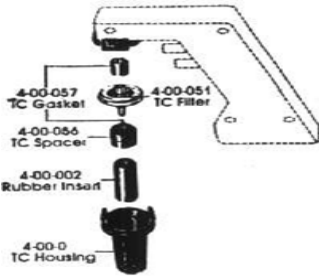

***PROMO ARTICOLI CONSUMO "2016-base"**

Validità promozione al 31-GENNAIO-2017

codice		Articolo	Prezzo Unit. x Conf in Euro iva esclusa	Note
gamma 20-..... etc.				
NUOVO PIPETTATORE AUTOMATICO " E-FILL PORTATILE " orig. MICROLIT				
UTILIZZABILE CON TUTTE LE PIPETTE SIEROLOGICHE IN PLASTICA, e/o IN VETRO , DI CAPACITA' VARIABILE da 1 fino a 100 ml.				
MODELLO FUNZIONANTE MEDIANTEPULSANTE DI CARICOPULSANTE DI SCARICOREGOLAZIONE IN CONTINUO (FAST/MEDIUM/SLOW) DELLA VELOCITA' DI ASPIRAZIONE e/o ESPULSIONEFILTRO IDROFOBICO 0,20 mcr. BATTERIA RICARICABILE NNALIMENTATORE DI RETE 230 Volt				
* COMODISSIMO **PRATICISSIMO** ***LEggerISSIMO***				
20-6531075		(GARANZIA 6 / sei MESI)	180,00	
NUOVO PIPETTATORE AUTOMATICO " TURBO-FIX PORTATILE " orig. T P P				
UTILIZZABILE CON TUTTE LE PIPETTE SIEROLOGICHE IN PLASTICA, e/o IN VETRO , DI CAPACITA' VARIABILE da 1 fino a 100 ml.				
MODELLO FUNZIONANTE MEDIANTEPULSANTE DI CARICOPULSANTE DI SCARICOREGOLAZIONE IN CONTINUO (FAST/MEDIUM/SLOW) DELLA VELOCITA' DI ASPIRAZIONE e/o ESPULSIONEFILTRO IDROFOBICO 0,45 mcr. BATTERIA RICARICABILE NNALIMENTATORE DI RETE 230 Volt				
* COMODISSIMO **PRATICISSIMO** ***LEggerISSIMO***				
04-DP.P94700		(GARANZIA 12/sei MESI)	355,00	
NUOVO PIPETTATORE AUTOMATICO " PIPET-AID XP PORTATILE "				
UTILIZZABILE CON TUTTE LE PIPETTE SIEROLOGICHE IN PLASTICA, e/o IN VETRO , DI CAPACITA' VARIABILE da 1 fino a 100 ml.				
MODELLO FUNZIONANTE MEDIANTEPULSANTE DI CARICO E SCARICO 3 " VELOCITA' SELEZIONABILI (FAST / MEDIUM / SLOW)FILTRO IDROFOBICO 0,80 mcr. BATTERIA RICARICABILE NIMH 9V.ALIMENTATORE DI RETE 230 Volt				
* COMODISSIMO **PRATICISSIMO** ***LEggerISSIMO***				
20-6540201		(GARANZIA 6 / sei MESI)	360,00	

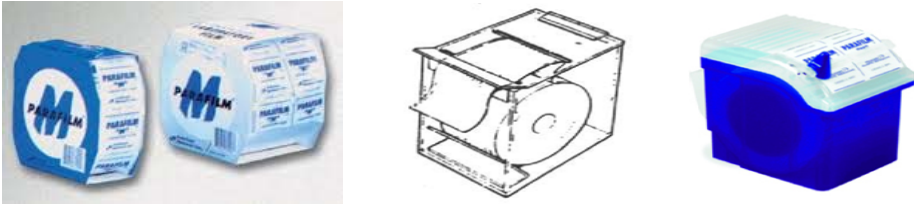

*PROMO ARTICOLI CONSUMO "2016-base"

Validità promozione al 31-GENNAIO-2017

codice gamma 20-.....	confezione	tipo Confez.	Articolo	Prezzo Unit. x Conf in Euro iva esclusa	Note
					
PARAFILM M					
ED ACCESSORI					
20-6701605	1 roll		Parafilm M cm. 10 x 38 metri	*22,50	<i>il più venduto</i>
20-6701605.x006	6 roll		idem come sopra // conf. bulk	120,00	<i>il più venduto</i>
20-6701611	1 roll		Parafilm M cm. 5 x 75 metri	24,30	
20-6701611.x006	6 roll		idem come sopra // conf. bulk	129,60	
20-6701691	1 pz		Box PLX trasparente per devolgimento Parafilm con taglierina	72,00	ad esaurimento
20-6701691	1 pz		Box bleu devolgimento Parafilm completo di taglierina	42,00	
20-6701692	1 pz		idem come sopra Box verde	42,00	
20-6701694	1 pz		idem come sopra Box rosso	42,00	
					
Koniche capacità 15 ml.					
Sterili xCentrifuga RCF 12.500 xG					
Koniche capacità 50 ml.					
Sterili xCentrifuga RCF 12.500 xG					
Koniche skirt capacità 50 ml.					
Sterili xCentrifuga RCF 10.500 xG					
20-6890210.x500	500 pz	x25 pz/ Sterili	TC Culture tubes PS d. 12x 75 mm.	112,00	con Snap-cap 2 pos
20-6890215.x500	500 pz	x25 pz/ Sterili	TC Culture tubes PP d. 12x 75 mm.	112,00	con Snap-cap 2 pos
20-6890220.x500	500 pz	x25 pz/ Sterili	TC Culture tubes PS d. 17x100 mm	118,00	con Snap-cap 2 pos
20-6890225.x500	500 pz	x25 pz/ Sterili	TC Culture tubes PP d. 17x100 mm	118,00	con Snap-cap 2 pos
20-6891015.CE.x500	500 pz	x50 pz/ Sterili	Provette coniche ml.15 grad.+t.v.	66,00	tipo Falcon 15 ml.
20-6891015.CE.x505	2.500 pz	x50 pz/ Sterili	idem come sopra // bulk in buste	264,00	tipo Falcon 15 ml.
20-6891017.Rkd	480 pz	Racked/ Sterili	idem come sopra // 12 Rack 40 pz.	*82,80	tipo su Rack 15 ml.
20-6891055.CE.x500	500 pz	x50 pz/ Sterili	Provette koniche ml.50 grad.+t.v.	76,00	tipo Falcon 50 ml.
20-6891055.CE.x505	2.500 pz	x50 pz/ Sterili	idem come sopra // bulk in buste	304,00	tipo Falcon 50 ml.
20-6891057.Rkd	480 pz	Racked/ Sterili	idem come sopra // 12 Rack 20 pz.	88,20	tipo su Rack 50 ml.
20-6891075.CE.x500	500 pz	x50 pz/ Sterili	Prov.Skirted kon.ml.50 grad.+t.v.	86,00	tipo Falcon 50 ml.
20-6891075.CE.x505	2.500 pz	x50 pz/ Sterili	idem come sopra // bulk in buste	344,00	tipo Falcon 50 ml.
20-6891077.Rkd	480 pz	Racked/ Sterili	idem come sopra // 12 Rack 20 pz.	97,20	tipo su Rack 50 ml.

*PROMO ARTICOLI CONSUMO "2016-base"

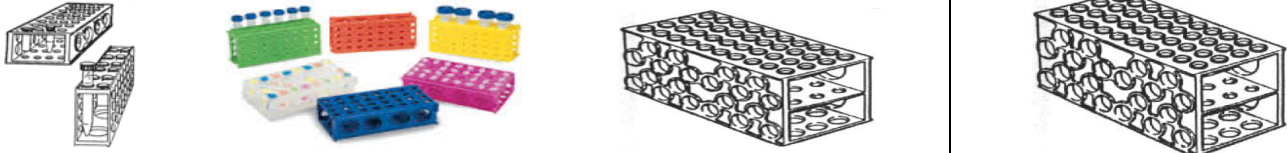
Validità promozione al 31-GENNAIO-2017

codice gamma 20-.....	confezione	tipo Confez.	Articolo	Prezzo Unit. x Conf in Euro iva esclusa	Note
					
20-750401?.x001	1 pz	colore ???	Rack PP 4 lati per 32x1,5-2,0 ml	4,80	Novità...
20-7504019.x005	5 pz	3 colori ass.ti	- 96x0,2 ml - 12x15 ml - 4x50 ml	21,60	Novità...
20-750501?.x001	1 pz	colore neutro	Rack PP 4 lati per 32x1,5-2,0 ml	5,20	ex 7503010...
20-7505019.x005	5 pz	5 colori ass.ti	- 32x0,5 ml - 12x15 ml - 4x50 ml	23,40	ex 7503011...
20-750801?.x001	1 pz	colore ???	Rack PP 4 lati per 40xd.mm. 12	9,00	ex 7503017...
20-7508019.x005	5 pz	5 colori ass.ti	-20x d.mm.20 -24x15ml -8x50ml	40,50	ex 7503017...
					
P C R R A C K S					
20-7510180.x001	1 pz	colore ???	Rack PCR "Workstation Rack-B"	20,00	senza Rack
20-7510180.x005	5 pz	5 colori ass.ti	per 32x0,2 +16x0,5 +24x1,5-2 ml	90,00	satellitare tipo A
20-7510200.x001	1 pz	colore ???	Rack PCR "Racking System A+B"	26,00	completo di Rack
20-7510200.x005	5 pz	5 colori ass.ti	per 32x0,2 +16x0,5 +24x1,5-2 ml	117,00	satellitare tipo A
20-7510220.x005	5 pz	5 colori ass.ti	Rack satellite 96 x0,2 ml. +coperchio	36,00	
20-7510222.x005	5 pz	5 colori ass.ti	Rack 96 x0,2 ml. +coperchio cerniere	30,00	
20-7510224.x005	5 pz	5 colori ass.ti	Rack sicurezza 96x0,2 ml.+coperchio	40,00	
					
U N I - D I S P R A C K S					
20-7520431.x010	10 pz	5 colori ass.ti	Rack PP 50 posti diam.mm. 12	26,40	
20-7520432.x010	10 pz	5 colori ass.ti	Rack PP 50 posti diam.mm. 16	28,00	
20-7520433.x010	10 pz	5 colori ass.ti	Rack PP 50 posti diam.mm. 18	28,00	
20-7520434.x010	10 pz	5 colori ass.ti	Rack PP 18 posti diam.mm. 20	30,40	xFalcon 15 ml.
20-7520437.x010	10 pz	5 colori ass.ti	Rack PP 18 posti diam.mm. 30	30,40	xFalcon 50 ml.





*PROMO ARTICOLI CONSUMO "2016-base"

Validità promozione al 31-GENNAIO-2017

codice gamma 20-.....	confezione	tipo Confez.	Articolo	Prezzo Unit. x Conf in €uro iva esclusa	Note
					
20-7521399.x010	10 pz	+ colori ass.ti	Rack PP 90 posti diam.mm. 13	58,40	
20-7521669.x010	10 pz	+ colori ass.ti	Rack PP 60 posti diam.mm. 16	58,40	
20-7521949.x010	10 pz	+ colori ass.ti	Rack PP 40 posti diam.mm. 19	58,40	xFalcon 15 ml.
20-7522929.x010	10 pz	+ colori ass.ti	Rack PP 24 posti diam.mm. 30	64,60	xFalcon 50 ml.
20-7523515	1 pz	wire-metal	Rack-wire 15 fori diam.mm. 18	17,00	xFalcon 15 ml.
20-7523550	1 pz	wire-metal	Rack-wire 8 fori diam.mm. 30	17,00	xFalcon 50 ml.
				TPP RACKS	
20-7523017.x001	1 pz	colore giallo	Rack TPP 18x15 ml. o 10x50 ml.	4,00	=DP.P99017.x001
20-7523019.x001	1 pz	colore giallo	Rack TPP 30x15 ml. o 20x50 ml.	4,80	=DP.P99019.x001
				UNI-K RACKS	
20-7523109.x010	10 pz	+ colori ass.ti	Rack PP 100 posti diam.mm. 11	58,40	
					
20-7523869.x010	10 pz	+ colori ass.ti	Racks PP 80 posti x 1,5 - 2,0 ml	32,00	80 posti
20-7523880.x001	1 pz	neutro	Box con coperchio xRack 80 posti	6,50	accessorio xRack 80
20-7524669.x010	10 pz	+ colori ass.ti	Racks PP 64 posti x 1,5 - 2,0 ml	68,80	64 posti
20-7524969.x010	10 pz	+ colori ass.ti	Racks PP 96 posti x 1,5 - 2,0 ml	80,00	96 posti

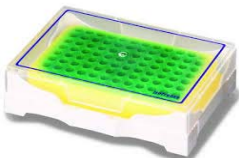
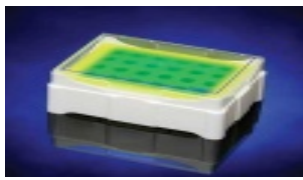

*PROMO ARTICOLI CONSUMO "2016-base"

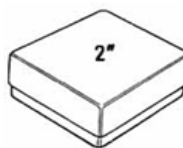
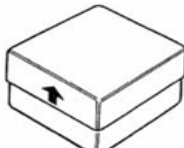
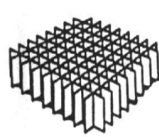
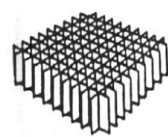
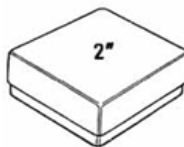
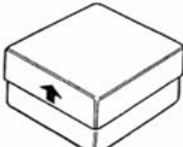
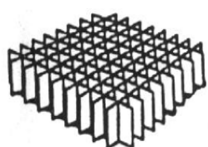
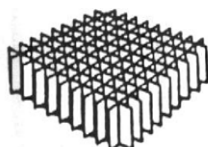
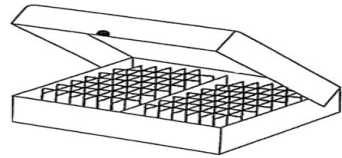
Validità promozione al 31-GENNAIO-2017

codice gamma 20-.....	confezione	tipo Confez.	Articolo	Prezzo Unit. x Conf in Euro iva esclusa	Note
					RACKS
per Microtubi 96 x 0,2 ml. per Stripstubi 96 x 0,2 ml.		per Microtubi 24 x 0,5 ml. per Microtubi 24 x 1,5 - 2,0 ml.			REFRIGERABILI
20-7525994	1 pz	colore pink	Rack-Chiller x 96 Mtubi 0,2 ml.	48,00	Vira Pourple a Pink
20-7525996	1 pz	colore green	Rack-Chiller x 96 Mtubi 0,2 ml.	48,00	Vira Yellow a Green
20-7526024	1 pz	colore pink	Rack-Chiller x 96 Mtubi 1,5-2 ml.	82,00	Vira Pourple a Pink
20-7526026	1 pz	colore green	Rack-Chiller x 96 Mtubi 1,5-2 ml.	82,00	Vira Yellow a Green
					
					
20-7710301	1 pz		Roll Alluminio cm. 30 x125 metri	*9,90	
20-7710330	1 pz		Roll Alluminio cm. 33 x125 metri	*12,60	
20-7710400	1 pz		Roll Alluminio cm. 40 x125 metri	*14,40	
20-7711300	1 pz		Roll PellicolaFilm cm. 30 x300 metri	*7,20	
CRYOBXES/SCATOLE senza GRIDS-DIVISORI (da acquistare separatamente)					
					 
20-8005420.x012	12 pz	senza Grids	Cryobox cartone/pvc (vuote bianche)	*22,50	
20-8005425.x012	12 pz	senza Grids	Cryobox cartone/pvc (vuote 4 colori)	*23,40	
20-8010813.x012	12 pz	Grids HQ	Grids cartone 81 cellette/posti	*22,50	con cellette diam. 13
20-8011003.x012	12 pz	Grids HQ	Grids cartone 100 cellette/posti	*23,40	con cellette diam. 12
20-8011443.x012	12 pz	Grids HQ	Grids cartone 144 cellette/posti	*32,40	con cellette diam. 9
CRYOBXES/SCATOLE con GRIDS-DIVISORI EKO a CORREDO					
					 
					
8005428/081.x012	12 pz	con Grid- 81	Cryobox cartone/pvc 81posti-Eko	37,80	con cellette diam. 13
8005428/100.x012	12 pz	con Grid-100	Cryobox cartone/pvc 100 posti-Eko	37,80	con cellette diam. 12
8006228/081.x012	12 pz	con Grid- 81	Cryobox-2/ cartone 81+81 posti	33,00	con cellette diam. 13
8006228/100.x012	12 pz	con Grid-100	Cryobox-2/ cartone 100+100 posti	33,00	con cellette diam. 12

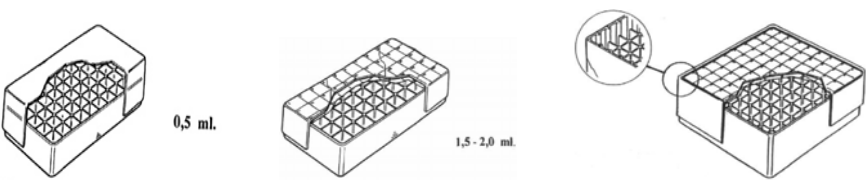

***PROMO ARTICOLI CONSUMO "2016-base"**

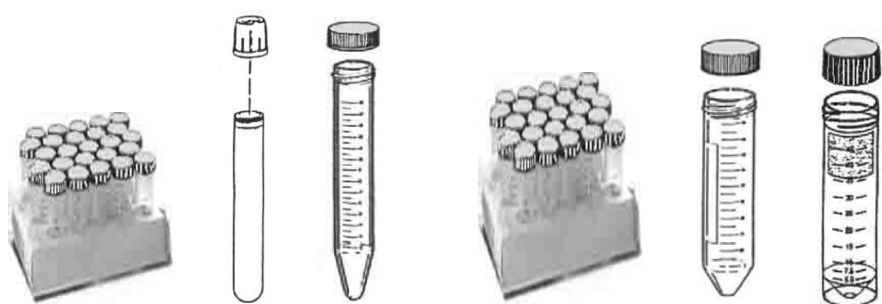
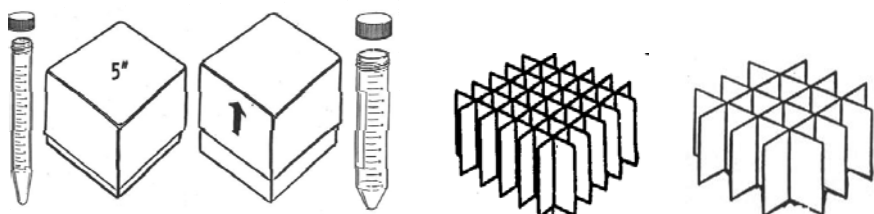
Validità promozione al 31-GENNAIO-2017

codice gamma 20-.....	confezione	tipo Confez.	Articolo	Prezzo Unit. x Conf in Euro iva esclusa	Note	
						Cryoboxes PP con Lift-off LID
						Cryoboxes PP con LID cernierato
20-8020550.x005	5 pz / neutri	fixGrid- 50	Cryobox PP 50x0,5 ml Lid lift-off	16,00	con cellette diam. 9	
20-8025500.x005	5 pz / neutri	fixGrid- 50	Cryobox PP 50x1,5 ml Lid lift-off	15,00	con cellette diam.12	
20-8425810.x005	5 pz / neutri	fixGrid- 81	Cryobox PP 81 posti Lid lift-off	27,50	con cellette diam.13	
20-8425830.x005	5 pz/colorati	fixGrid- 81	idem come sopra in 5 col. ass.ti	27,50	con cellette diam.13	
20-8425610.x005	5 pz / neutri	fixGrid- 50	Cryobox PP 50 posti Lid+cerniere	15,50	con cellette diam.12	
20-8425630.x005	5 pz/colorati	fixGrid- 50	idem come sopra in 5 col. ass.ti	15,50	con cellette diam.12	
20-8425710.x005	5 pz / neutri	fixGrid-100	Cryobox PP 100 posti Lid+cerniere	28,00	con cellette diam.12	
20-8425730.x005	5 pz/colorati	fixGrid-100	idem come sopra in 5 col. ass.ti	28,00	con cellette diam.12	
						UNI RACKS per FALCON
20-8052015.x006	6 pz/ white	xFalcon 15 ml.	Box/racks cartone 40 fori d. 17	18,00	da Banco/xFreezer	
20-8052015.x012	12 pz/ white	xFalcon 15 ml.	idem come sopra // conf. bulk	28,80	da Banco/xFreezer	
20-8052050.x006	6 pz/ white	xFalcon 50 ml.	Box/racks cartone 20 fori d. 17	18,00	da Banco/xFreezer	
20-8052050.x012	12 pz/ white	xFalcon 50 ml.	idem come sopra // conf. bulk	28,80	da Banco/xFreezer	
						Cardboard Cryoboxes per FALCON



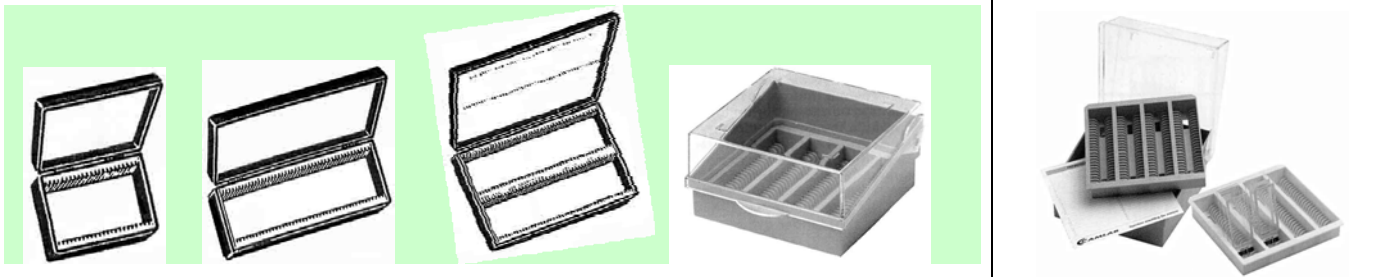



***PROMO ARTICOLI CONSUMO "2016-base"**

Validità promozione al 31-GENNAIO-2017

codice gamma 20-.....	confezione	tipo Confez.	Articolo	Prezzo Unit. x Conf in Euro iva esclusa	Note
20-8053620.x012	12 pz	senza Grid	Cryobox cartone/pvc 5" Lift-off Lid	49,00	altezza mm.78-121
20-8061536.x012	12 pz	accessori	Grid cartone quality 36 posti d.17	70,00	altezza mm. 100
20-8063016.x012	12 pz	accessori	Grid cartone quality 16 posti d.29	50,00	altezza mm. 50
					
20-8127600.x010	10 pz/ colore	Bleu/o/grigio	Scatole x Vetrini portaoggetto 25 posti ,rettangolari	29,70	
20-8127700.x010	10 pz/ colore	Black/nero	Scatole x Vetrini portaoggetto 50 posti ,rettangolari	37,80	
20-8127800.x010	10 pz/ colore	Bleu/o/red	Scatole x Vetrini portaoggetto 100 posti ,rettangolari	48,60	
20-8104010.x005	5 pz/ colore	Bleu	Scatole x Vetrini portaoggetto 100 posti ,mm. 133x133 x 86 h.	42,00	ad esaurimento
20-8104020.x005	5 pz/ colore	Green	100 posti idem come sopra	42,00	
20-8104030.x005	5 pz/ colore	Orange	100 posti idem come sopra	42,00	
20-8104040.x005	5 pz/ colore	Red	100 posti idem come sopra	42,00	
20-8104060.x005	5 pz/ colore	Yellow	100 posti idem come sopra	42,00	
20-8400180.x001	1 pz/ colore	naturale	Spruzzetta PET Kcapacità 100 ml.	1,45	
20-8400182.x001	1 pz/ colore	naturale	Spruzzetta PET Kcapacità 250 ml.	1,75	
20-8400183.x001	1 pz/ colore	naturale	Spruzzetta PET Kcapacità 500 ml.	1,95	
20-8400185.x001	1 pz/ colore	Naturale	Spruzzetta PET Kcapacità 1000 ml.	2,60	
20-8400259.x001	1 pz/ colore	tappo a scelta sec. disponibil.	Spruzzetta PET Kcapacità 250 ml. tappo GL45 con cannucchia curva	2,60	
20-8400509.x001	1 pz/ colore	tappo a scelta sec. disponibil.	Spruzzetta PET Kcapacità 500 ml. tappo GL45 con cannucchia curva	3,00	
SIRINGHE SPECIALI a 2 COMPONENTI PP + PE ATTACCO LUER-SLIP (tipo INNESTO)					
					
SENZA AGO LUER-INNESTO					
20-8655001.x100	100 x 1 pz	Siringhe INJEKT-F ml. 1 att.Luer-innesto, PP+PE		21,00	BB=9166017V
20-8655002.x100	100 x 1 pz	Siringhe INJEKT ml. 2 att.Luer-innesto, PP+PE		5,10	BB=4606027V
20-8655005.x100	100 x 1 pz	Siringhe INJEKT ml. 5 att.Luer-innesto, PP+PE		7,50	BB=4606051V
20-8655010.x100	100 x 1 pz	Siringhe INJEKT ml.10 att.Luer-innesto, PP+PE		11,00	BB=4606108V
20-8655020.x100	100 x 1 pz	Siringhe INJEKT ml.20 att.Luer-innesto, PP+PE		16,70	BB=4606205V



*PROMO ARTICOLI CONSUMO "2016-base"

Validità promozione al 31-GENNAIO-2017

codice gamma 20-.....	confezione	tipo Confez.	Articolo	Prezzo Unit. x Conf in Euro iva esclusa	Note
SIRINGHE DISCARDIT B & D a 2 COMPONENTI PP + PE ATTACCO LUER-SLIP (tipo INNESTO)					SENZA AGO LUER-INNESTO 
20-8633002.x100	100 x 1 pz	Siringhe Discardit ml. 2 att.Luer-innesto, PP+PE		9,00	
20-8633005.x100	100 x 1 pz	Siringhe Discardit ml. 5 att.Luer-innesto, PP+PE		9,80	
20-8633010.x100	100 x 1 pz	Siringhe Discardit ml.10 att.Luer-innesto, PP+PE		11,60	
20-8633020.x080	80 x 1 pz	Siringhe Discardit ml.20 att.Luer-innesto, PP+PE		16,00	
SIRINGHE STERILI SPECIALI a 2 COMPONENTI PP + PE ATTACCO LUER-LOCK SICUREZZA (tipo INNESTO + BAIONETTA)					SENZA AGO LUER-LOCK 
20-8657002.x100	100 x 1 pz	Siringhe HS2 ml. 2 attacco Luer-Lock, PP+PE		9,00	
20-8657005.x100	100 x 1 pz	Siringhe HS5 ml. 5 attacco Luer-Lock, PP+PE		13,00	
20-8657010.x100	100 x 1 pz	Siringhe HS10 ml.10 attacco Luer-Lock, PP+PE		16,50	
20-8657020.x100	100 x 1 pz	Siringhe HS20 ml.20 attacco Luer-Lock, PP+PE		19,20	
AGHI STERILI ATTACCO LUER AGHI STERILI ATTACCO LUER SPECIALI					
20-8500001.x100	100 x 1 pz	IW/unica	AGHI Sterili GIALLI 20 G1 1/2	5,25	
20-8500002.x100	100 x 1 pz	IW/unica	AGHI Sterili VERDI 21 G1 1/2	5,25	
20-8500012.x100	100 x 1 pz	IW/unica	AGHI Sterili NERI 22 G1 1/4	5,25	
20-8500014.x100	100 x 1 pz	IW/unica	AGHI Sterili GIALLI 23 G1 1/4	5,25	
20-8500018.x995	5000 pz	50 x 100 pz	AGHI Sterili ROSA 18 G1 1/2	252,00	
20-8500025.x995	5000 pz	50 x 100 pz	AGHI Sterili dispos. 25 G 5/8	250,00	
20-8665120.x100	100 x 1 pz	Aghi Sterili Rosa	tipo 18Gx 0.8 x40 mm.	11,00	
20-8665791.x100	100 x 1 pz	Aghi Sterili Gialli	tipo 20Gx 0.90 x70 mm.	8,20	
20-8665643.x100	100 x 1 pz	Aghi Sterili Verde	tipo 21Gx 0.80 x40 mm.	25,20	
20-8650018.x100	100 x 1 pz	Aghi Sterili Neri	tipo 22Gx 0.70 x50 mm.	9,10	
20-8657853.x100	100 x 1 pz	Aghi Sterili Orange	tipo 25 Gx 0.50 16 mm.	6,60	
20-8657683.x100	100 x 1 pz	Aghi Sterili Brown	tipo 26 Gx 0.45 x25 mm.	6,60	
SIRINGHE STERILI SENZA AGO a 3 COMPONENTI PP+PE+LATEX ATTACCO LUER-INNESTO					
					SENZA AGO LUER-INNESTO 
20-8503015.x100	100 x 1 pz	Siringhe Sterili ml. 1 senza Ago att.luer centrale		18,00	
20-8503020.x100	100 x 1 pz	Siringhe Sterili ml. 2 senza Ago att.luer centrale		12,00	
20-8503050.x100	100 x 1 pz	Siringhe Sterili ml. 5 senza Ago att.luer centrale		13,00	
20-8503100.x100	100 x 1 pz	Siringhe Sterili ml. 10 senza Ago att.luer centrale		16,00	
20-8503208.x100	120 x 1 pz	Siringhe Sterili ml. 20 senza Ago att.luer centrale		36,00	
20-8503505.x100	60 x 1 pz	Siringhe Sterili ml. 50 senza Ago att.luer centrale		52,00	

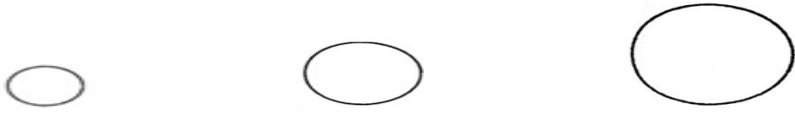

***PROMO ARTICOLI CONSUMO "2016-base"**

Validità promozione al 31-GENNAIO-2017

codice gamma 20-.....	confezione	tipo Confez.	Articolo	Prezzo Unit. x Conf in Euro iva esclusa	Note
UNI VETRINI PORTAOGGETTO PRELAVATI-SGRASSATI CON BORDI					
					
20-9101101.x500 20-9101101.x505	Box 500 pz Case 2.500 pz		UD Vetrini portaoggetto TAGLIATI mm. 26 x 76, bordi tagliati-grezzi , spess. 1 mm.	*18,90 **75,60	
20-9101103.x500 20-9101103.x505	Box 500 pz Case 2.500 pz		UD Vetrini portaoggetto MOLATI mm. 26 x 76, bordi molati-levigati , spess. 1 mm.	*22,50 **90,00	
20-9101104.x500 20-9101104.x505	Box 500 pz banda sabbziata Case 2.500 pz		UD Vetrini portaoggetto MOLATI mm. 26 x 76, banda sabbziata bordi molati-levigati , spess. 1 mm. con banda opaca serigrafata	*28,80 **115,20	
UNI VETRINI COPRIOGGETTO QUADRATI E RETTANGOLARI PRELAVATI-SGRASSATI CON BORDI MOLATI					
					
20-9131010.x990 20-9131010.x995	Box 10.000 pz Case 50.000 pz		UD Vetrini coprioggetto quadri mm. 10 x 10, spessore 0,13-0,17 mm (<i>misura speciale</i>)	135,00 607,00	(<i>misura speciale</i>) (<i>misura speciale</i>)
20-9131818.x900 20-9131818.x905	Box 1.000 pz Case 5.000 pz		UD Vetrini coprioggetto quadri mm. 18 x 18, spessore 0,13-0,17 mm	*9,90 **39,60	
20-9132020.x990 20-9132020.x995	Box 1.000 pz Case 5.000 pz		UD Vetrini coprioggetto quadri mm. 20 x 20, spessore 0,13-0,17 mm	*11,16 **44,65	
20-9132222.x900 20-9132222.x905	Box 1.000 pz Case 5.000 pz		UD Vetrini coprioggetto quadri mm. 22 x 22, spessore 0,13-0,17 mm	*12,06 **48,25	
20-9132424.x900 20-9132424.x905	Box 1.000 pz Case 5.000 pz		UD Vetrini coprioggetto quadri mm.24 x 24, spessore 0,13-0,17 mm	*14,40 **57,60	
20-9152126.x900 20-9152126.x905	Box 1.000 pz Case 5.000 pz		UD Vetrini coprioggetto rettangolari mm. 21 x26, spessore 0,13-0,17 mm	*15,12 **60,50	
20-9152432.x900 20-9152432.x905	Box 1.000 pz Case 5.000 pz		UD Vetrini coprioggetto rettangolari mm. 24 x32, spessore 0,13-0,17 mm	*23,22 **92,90	
20-9152450.x900 20-9152450.x905	Box 1.000 pz Case 5.000 pz		UD Vetrini coprioggetto rettangolari mm. 24 x50, spessore 0,13-0,17 mm	*27,90 **111,60	
20-9152460.x900 20-9152460.x905	Box 1.000 pz Case 5.000 pz		UD Vetrini coprioggetto rettangolari mm. 24 x60, spessore 0,13-0,17 mm	*33,66 **134,65	
UNI VETRINI COPRIOGGETTO ROUND =CIRCOLARI PRELAVATI-SGRASSATI CON BORDI MOLATI					
					
20-9176010.x900	Box 1.000 pz		UD Vetrini copri oggetto rotondi diam.mm.10	**31,20	
20-9176012.x900	Box 1.000 pz		UD Vetrini copri oggetto rotondi diam.mm.10	**32,00	
20-9176015.x900	Box 1.000 pz		UD Vetrini copri oggetto rotondi diam.mm.10	**36,00	



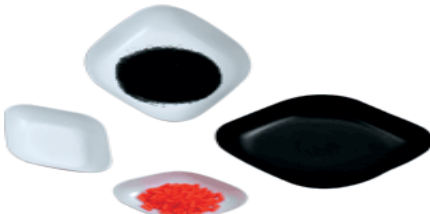

***PROMO ARTICOLI CONSUMO "2016-base"**

Validità promozione al 31-GENNAIO-2017

codice gamma 20-.....	confezione	tipo Confez.	Articolo	Prezzo Unit. x Conf in Euro iva esclusa	Note
ANCHE IN AZZURRO (stessi costi) MA SOLO SE DISPONIBILI A PRONTA CONSEGNA					
				U N I VASCHETTE PESATA IN HIPS	
TUTTE IN VERSIONE ANTISTATICA - PRODUZIONE DI QUALITA'					
20-9581044.x500	500 pz	white quadre	Vaschette pesata HIPS mm. 44x 44	19,00	
20-9581047.x500	500 pz	black quadre	ml. 7 idem come sopra in black	19,00	
20-9581080.x500	500 pz	white quadre	Vaschette pesata HIPS mm. 80x 80	33,00	
20-9581087.x500	500 pz	black quadre	ml. 100 idem come sopra in black	33,00	
20-9581140.x500	500 pz	white quadre	Vaschette pesata HIPS mm. 140x140	66,00	
20-9581147.x500	500 pz	black quadre	ml. 250 idem come sopra in black	66,00	
				U N I VASCHETTE PESATA IN HIPS	
TUTTE IN VERSIONE ANTISTATICA - PRODUZIONE DI QUALITA'					
20-9582050.x500	500 pz	white diamond	Vaschette pesata HIPS mm. 55x 35	20,00	altezza mm. 6
20-9582057.x500	500 pz	black diamond	ml. 5 idem come sopra in black	20,00	altezza mm. 6
20-9582070.x500	500 pz	white diamond	Vaschette pesata HIPS mm. 71x 46	29,50	altezza mm. 14
20-9582077.x500	500 pz	black diamond	ml. 25 idem come sopra in black	29,50	altezza mm. 14
20-9582080.x500	500 pz	white diamond	Vaschette pesata HIPS mm. 80x 60	30,50	altezza mm. 14
20-9582087.x500	500 pz	black diamond	ml. 30 idem come sopra in black	30,50	altezza mm. 14
20-9582125.x500	500 pz	white diamond	Vaschette pesata HIPS mm. 125x100	62,50	altezza mm. 19
20-9582127.x500	500 pz	black diamond	ml. 125 idem come sopra in black	62,50	altezza mm. 19
				U N I VASCHETTE IN ALLUMINIO	
20-9584043.x100	100 pz	x essiccazioni	Vaschette Alluminio diam. mm. 43	9,00	altezza mm. 12
20-9584057.x100	100 pz	x essiccazioni	Vaschette Alluminio diam. mm. 57	10,00	altezza mm. 14
20-9584070.x500	100 pz	x essiccazioni	Vaschette Alluminio diam. mm. 70	13,00	altezza mm. 16
20-9584125.x500	50 pz	x essiccazioni	Vaschette Alluminio diam. mm.100	15,50	altezza mm. 8

***PROMO ARTICOLI CONSUMO "2016-base"**

Validità promozione al 31-GENNAIO-2017

					
					
20-9611002.x100	100 pz	tappi vite N8	Vials vetro 1st HC d.mm. 12x35 h.	35,00	N8 /capacità ml. 2
20-9611002.x990	1.000 pz	tappi vite N8	idem come sopra // conf. bulk	315,00	N8 /capacità ml. 2
20-9611004.x100	100 pz	tappi vite N13	Vials vetro 1st HC d.mm. 15x45 h.	27,00	N13 /capacità ml. 4
20-9611004.x990	1.000 pz	tappi vite N13	idem come sopra // conf. bulk	243,00	N13 /capacità ml. 4
20-9611008.x100	100 pz	tappi vite N15	Vials vetro 1st HC d.mm. 17x60 h.	37,20	N15 /capacità ml. 8
20-9611008.x990	1.000 pz	tappi vite N15	idem come sopra // conf. bulk	334,80	N15 /capacità ml. 8
20-9611012.x100	100 pz	tappi vite N15	Vials vetro 1st HC d.mm. 19x65 h.	39,20	N15 /capacità ml. 12
20-9611012.x990	1.000 pz	tappi vite N15	idem come sopra // conf. bulk	352,80	N15 /capacità ml. 12

RIEPILOGO**CONDIZIONI GENERALI VALIDITA' PROMOZIONE**

PER INFORMAZIONI , CHIARIMENTI E PREVENTIVI SPECIFICI CONTATTARE

Sede – Uffici di Napoli tel. 081 – 7614433 tel. 081 – 7612904	Filiale – Uffici di Milano tel. 02 – 4692580 tel. 02 – 4693618
mail : edl@delchimica.com	mail : info@delchimicamilano.com
mail : vendite@delchimica.com	mail : a.deluca@delchimicamilano.com

Con i più distinti saluti

Delchimica Scientific Glassware S.r.l. / Sede di NAPOLI

Eugenio de Luca

Con i più distinti saluti

Delchimica Scientific Glassware S.r.l. / Filiale di MILANO

Antonio de Luca

www.delchimica.com/promozionale/